



Nimi/Name

Parker 179x119+Ter_16

Joonis/Zeichnung/Drawing

3D

Profiil/Profil/Profile

1.6x11.3

Kuupäev/Datum/Date

03.05.2018

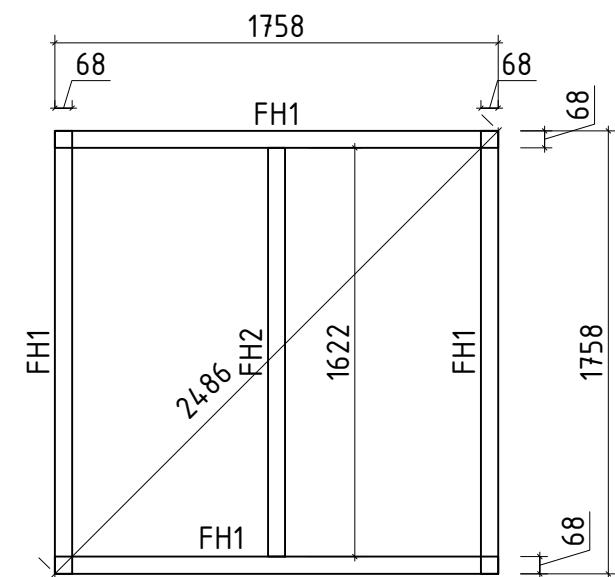
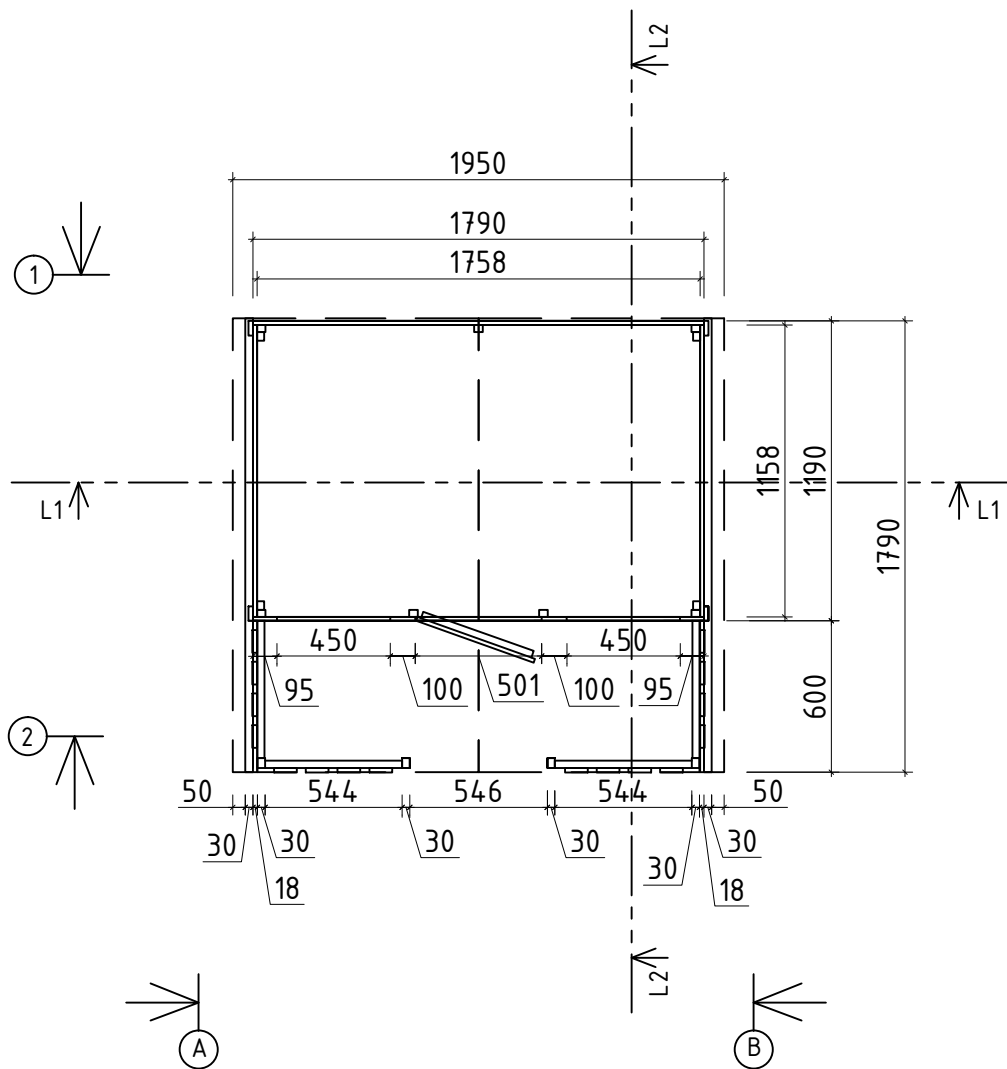

Alustalade plaan, Lagerholzplan, Foundation beams

Nimi/Name	Parker 179x119+Ter_16		
Joonis/Zeichnung/Drawing	Põhiplaan_Grundplan_Plan		
Profil/Profil/Profile	1.6x11.3	Kuupäev/Datum/Date	03.05.2018

Sein / Wand / Wall 1

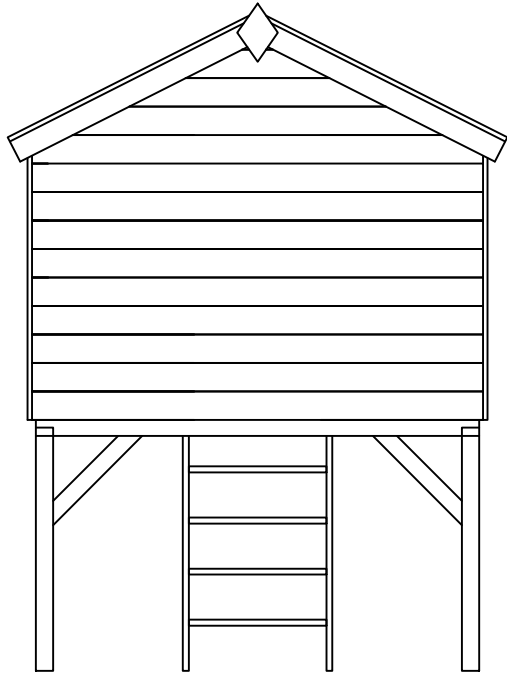

Sein / Wand / Wall 2

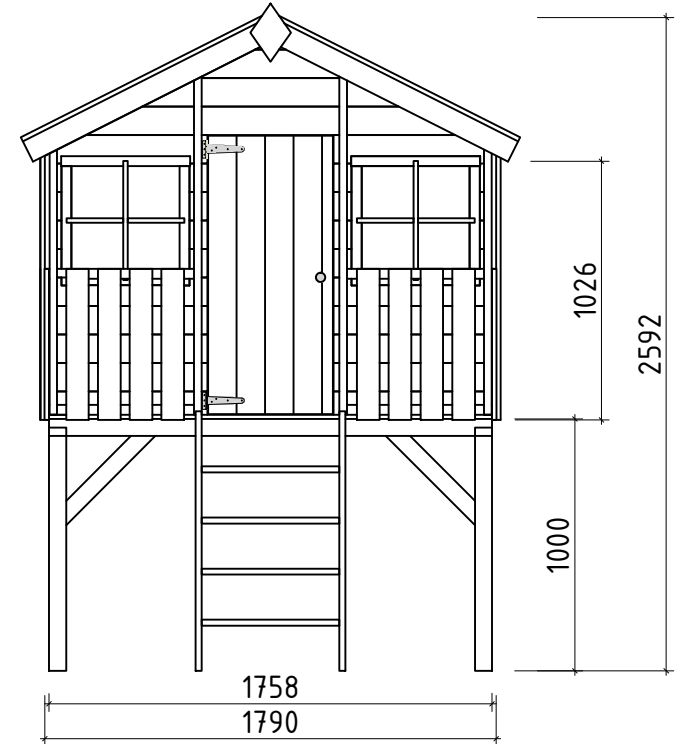

Nimi/Name	Parker 179x119+Ter_16	
Joonis/Zeichnung/Drawing	SEIN/WAND/WALL 1, 2	
Profiil/Profil/Profile	1.6x11.3	Kuupäev/Datum/Date 03.05.2018

Sein / Wand / Wall A

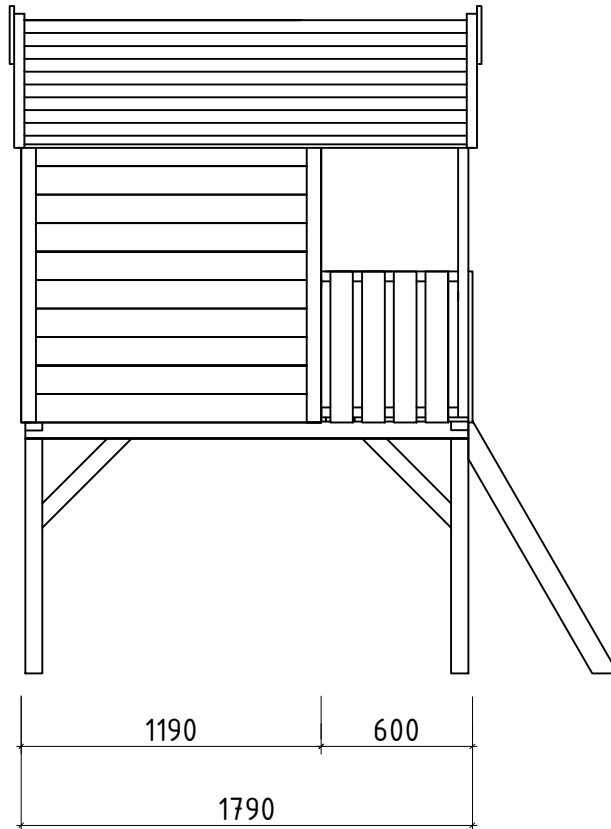

Sein / Wand / Wall B

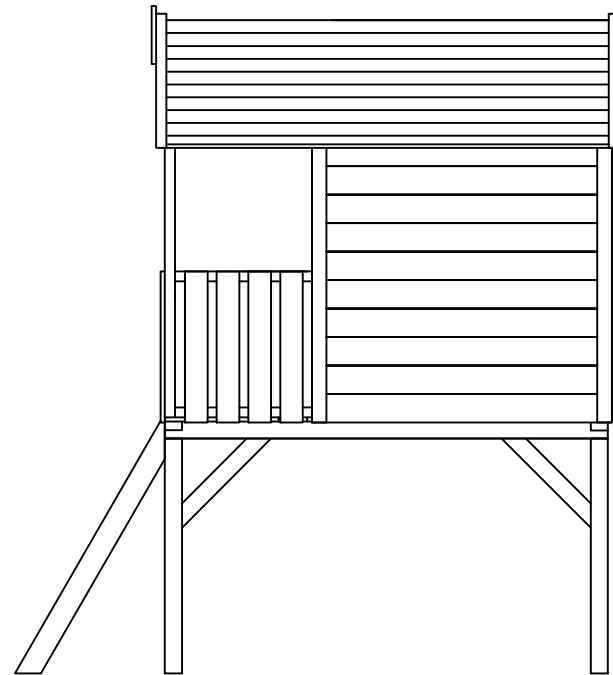

Nimi/Name	Parker 179x119+Ter_16	
Joonis/Zeichnung/Drawing	SEIN/WAND/WALL A, B	
Profiil/Profil/Profile	1.6x11.3	Kuupäev/Datum/Date 03.05.2018



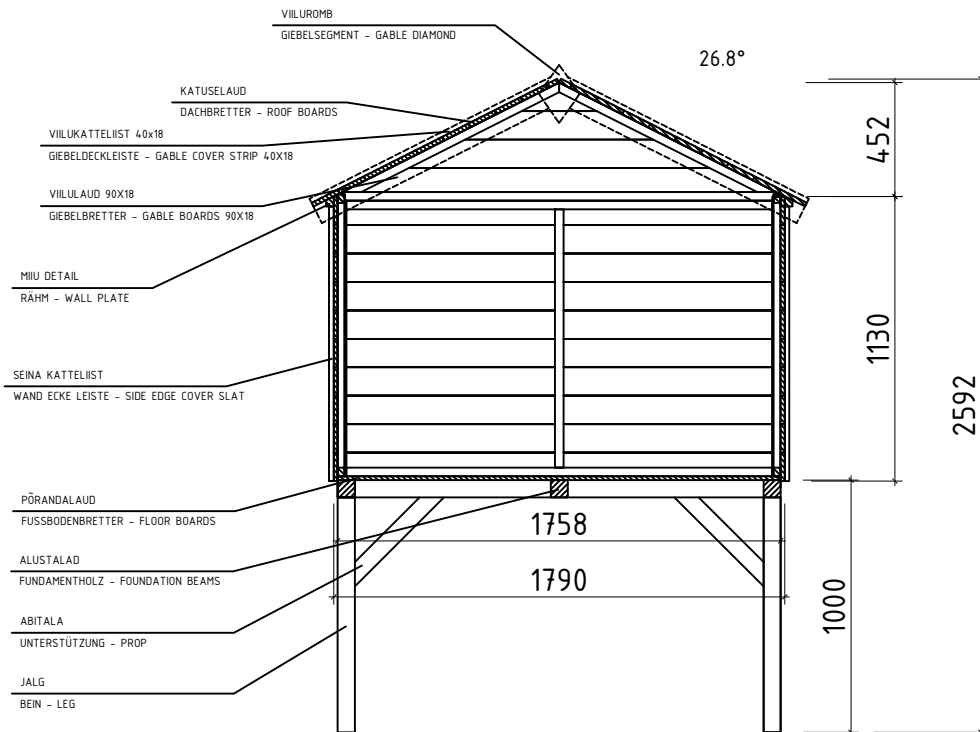

L1-L1

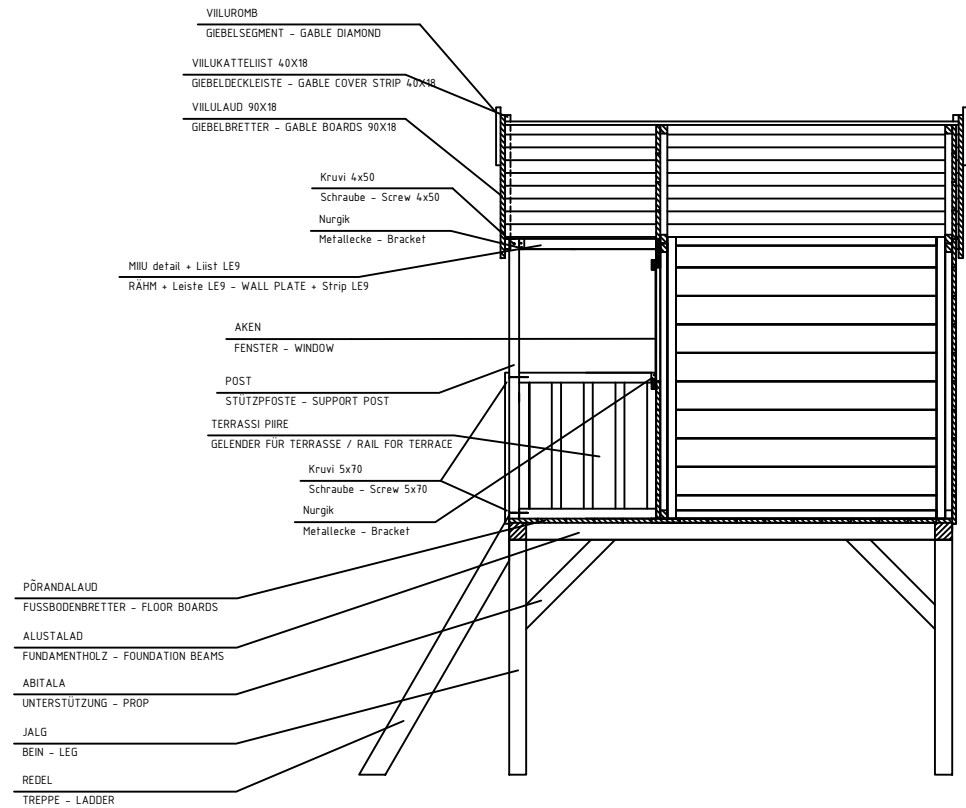



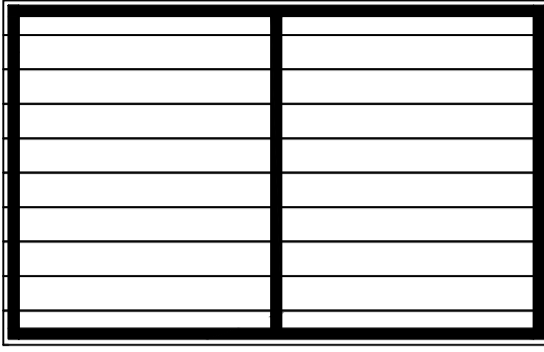

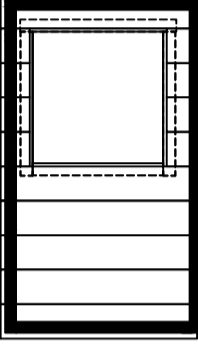
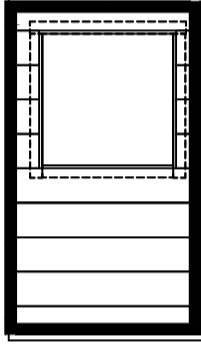
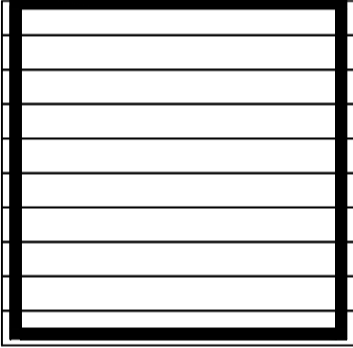
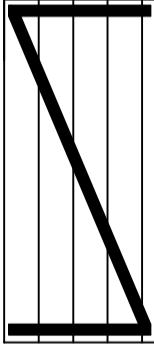
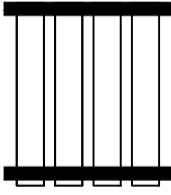
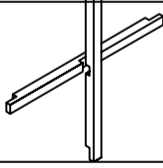
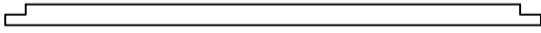
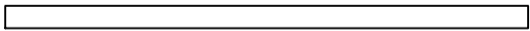

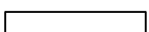
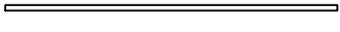
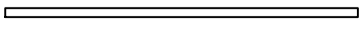

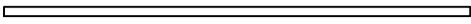
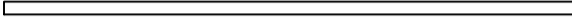
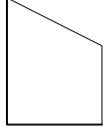

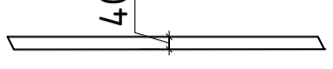

L2-L2

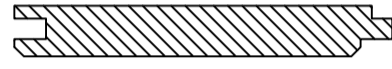
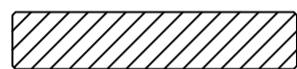

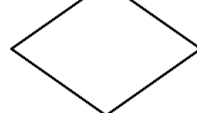
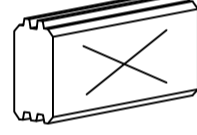
Nimi/Name	Parker 179x119+Ter_16	
Joonis/Zeichnung/Drawing	Lõige/Schnitt/Section	
Profil/Profil/Profile	1.6x11.3	Kuupäev/Datum/Date 03.05.2018

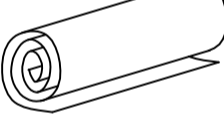
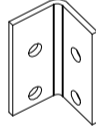
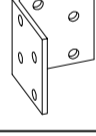
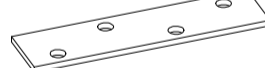
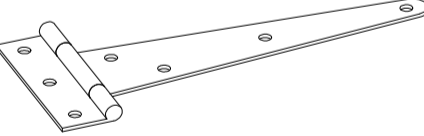
Pos	Spetsifikatsioon/Teieliste/Specification Parker 179x119+Ter_16		Tk. Stck. Pcs.	Profil Profil Profile (mm)	Pikkus Länge Length (mm)	
EL1	Sein / Wand / Wall 1		1	1790x1130		
EL2	Sein / Wand / Wall 1 Sein / Wand / Wall 2		2	1790x452		
EL3	Sein / Wand / Wall 2 aknaga / mit Fenster / with Window		✓	1	645x1130	
EL4	Sein / Wand / Wall 2 aknaga / mit Fenster / with Window		✓	1	645x1130	
EL5	Sein / Wand / Wall 3 Sein / Wand / Wall 4		2	1158x1130		
EL6	Uks / Tür / Door 495x1105		1	495x1105		
EL7	Terrassi piire Gelender für Terrasse / Rail for Terrace		4	544x600		
	Prossid - Sprossen - Muntins		2+2	18x18	470	
FH1		ALUSTALA - FUNDAMENTHOLZ - FOUNDATION BEAM 	4	68x68	1758	
FH2		ALUSTALA - FUNDAMENTHOLZ - FOUNDATION BEAM 	1	68x68	1622	
FH3		JALG - BEIN - LEG 	4	68x68	932	
FH4		ABITALA - UNTERSTÜTZUNG - PROP 	✓	8	68x68	500
LE5		Seina katteliist - Wand ecke leiste - Side edge cover slat 	4	58x18	1090	
LE3		Post - Stützpfofte - Support post 	2	40x30	1110	
Kood	Parker 179x119+Ter_16	Materjal	1.6x11.3	File	Parker 179x119+Ter_16 KLIEN... Nõutav 1/3	

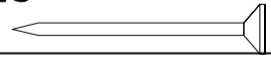
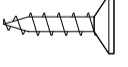
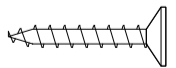
Pos	Spetsifikatsioon/Teieliste/Specification Parker 179x119+Ter_16			Tk. Stck. Pcs.	Profiil Profil Profile (mm)	Pikkus Länge Length (mm)
LE8	Post - Stützpfofte - Support post 			2	40x30	1409
LE1	Miiu detail - Rähm - Wallplate   26.8°			2	30x40	1800
LE9	Liist - Leiste - Strip 			2	90x18	600
LE10	KATUSE ABITALA - DACH UNTERSTÜTZUNG - ROOF PROP 26.8°  26.8°			2	30x40	1003
TR1	REDEL - TREPPE - LADDER 30°  60°			2	90x24	1190
TR2	REDEL - TREPPE - LADDER 			4	90x24	546
	KATUSELAUD - DACHBRETTER - ROOF BOARDS		✓	20+1	113x16	1800
	PÕRANDALAUD - FUSSBODENBRETTER - FLOOR BOARDS		✓	16+1	113x16	1758
G2-1	VIILULAUD - GIEBELBRETTER - GABLE BOARDS 90X18	 26.8°	✓	4	90x18	1175
G6-1	VIILUKATTELIIST - GIEBELDECKLEISTE - GABLE COVER STRIPS 40X18		✓	4	40x18	1175
GS	VIILUROMB - GIEBELSEGMENT - GABLE DIAMOND			2		
SH	LÖÖGIKLOTS - SCHLAGHÖLZER - MOUNTING PIECES			3		
TK2	UKSENUPP väike - TÜRKNOPF klein - KNOB small			2		
	KATUSEPAPP - DACHPAPPE - ROOFING FELT		✓		1.8m-3st	5.4m
ME	NURGIK - METALLECKE - BRACKET 20x20x40			4		
ME	NURGIK - METALLECKE - BRACKET 40x40x40			4		
NP01	NAELUTUSPLAAT - NAGELPLATTEN - NAIL PLATES 80x20			1		
S02	T-HING - SCHARNIER - HINGE 150x63			2		
NG3	PAPINAEL - DACHPAPPNÄGEL - ROOFING NAILS 2.0x18			80		
NG4	NAEL - NÄGEL - NAILS 2.0x40	Põrandalaud - Fussbodenbretter - Floor boards Katuselaud - Dachbretter - Roof boards 		176		
SR23	KRUVI - SCHRAUBEN - SCREWS 3.0x20	Prossid - Sprossen - Muntins 		8		
SR16	KRUVI - SCHRAUBEN - SCREWS 3.5x25			48		
	Nurgik - Metallecke - Bracket 20x20x40 (4x4stck/pcs) Viilukatteliist - Giebeldeckleiste - Gable cover strip (12stck/pcs) T-hing - Scharnier - Hinge (2x7stck/pcs) Uksenupp - Türgriff - Knob (2stck/pcs) Naelutusplaat - Nagelplatten - Nail plates (4stck/pcs)					
Kood	Parker 179x119+Ter_16	Materjal	1.6x11.3	File	Parker 179x119+Ter_16 KLIENDwg 2/3	

1. Abitala - Unterstützung - Prop

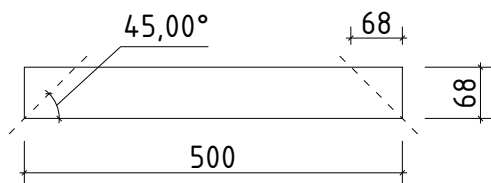

Palun lõigata
 Bitte absägen - Please cut

EL3, EL4

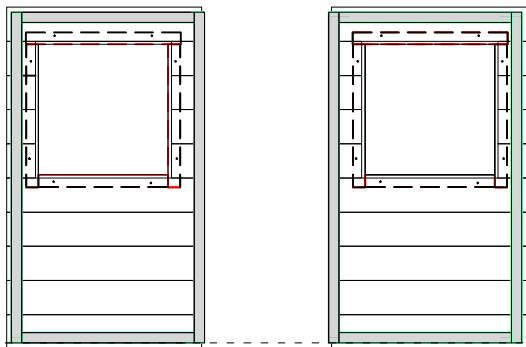

Palun lõigata
 Bitte absägen - Please cut

2.

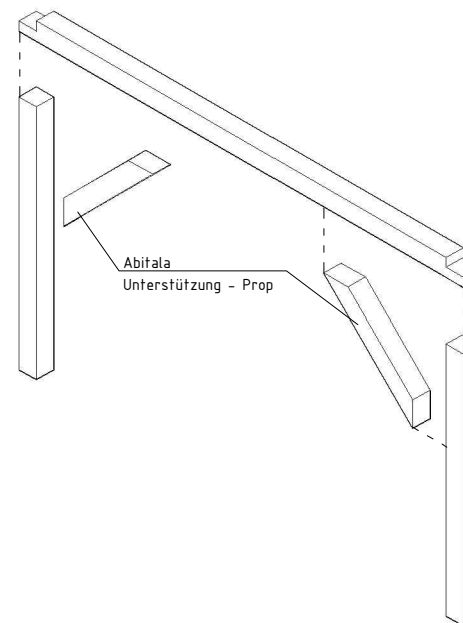

3.

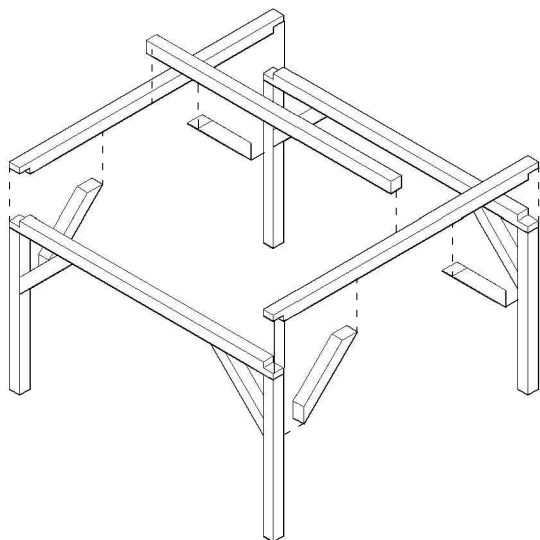

Nurgik 40x40x40
 Metallecke - Bracket 40x40x40

Kruvi 3.5x45
 Schraube - Screw 3.5x45

Parker 179x119+Ter_16

4.

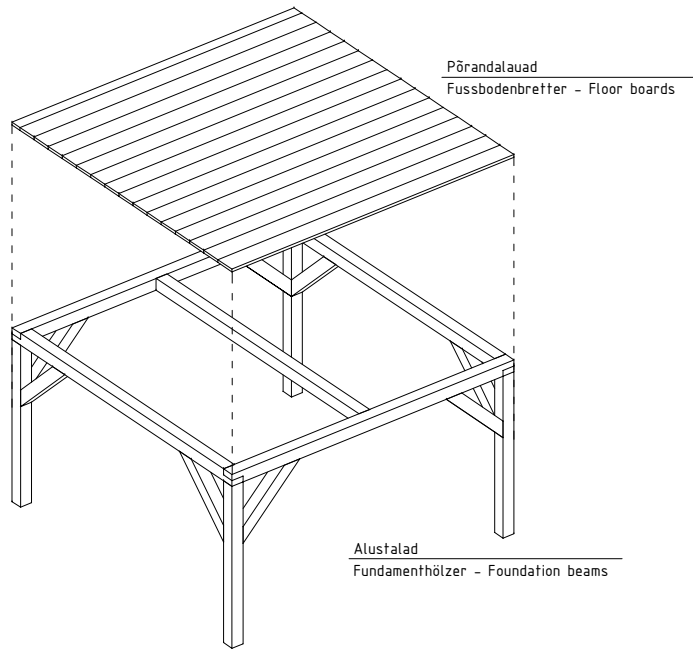

5.

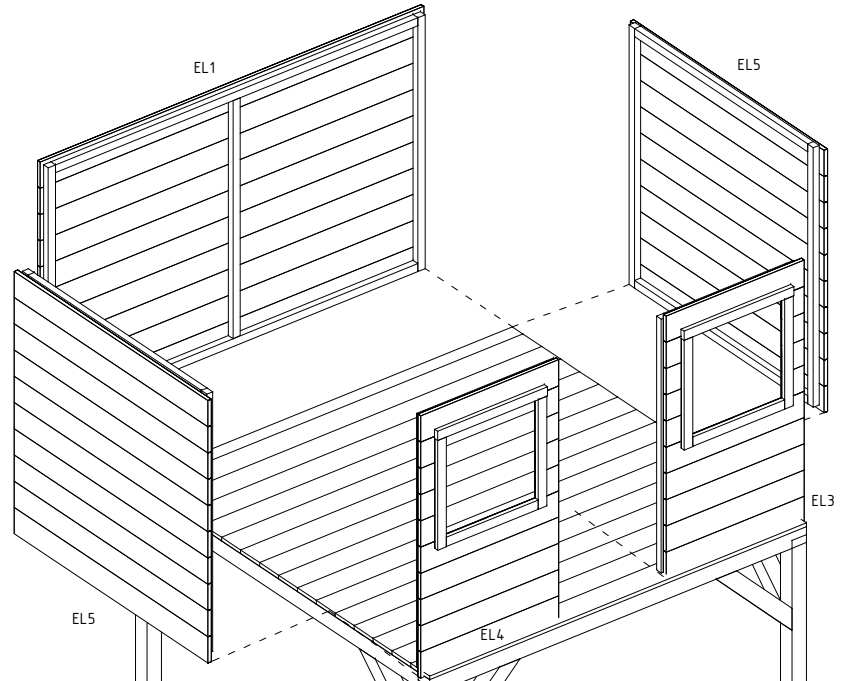

6.

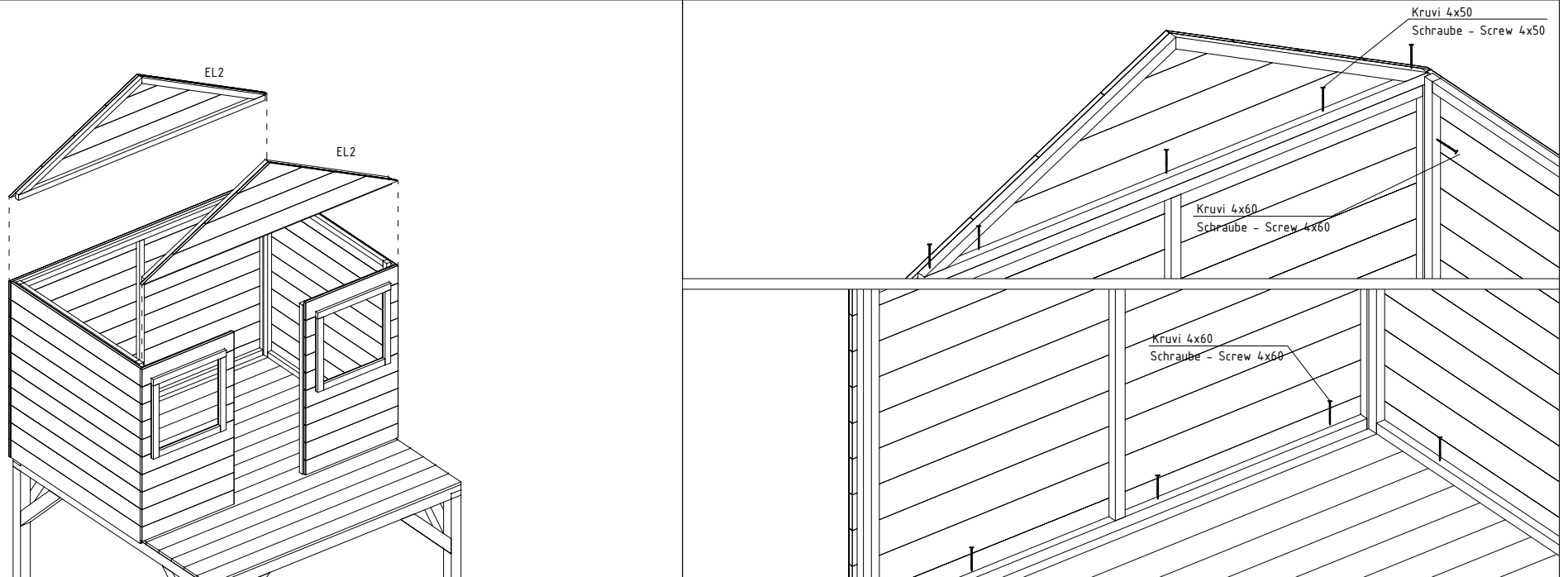

Parker 179x119+Ter_16

7.

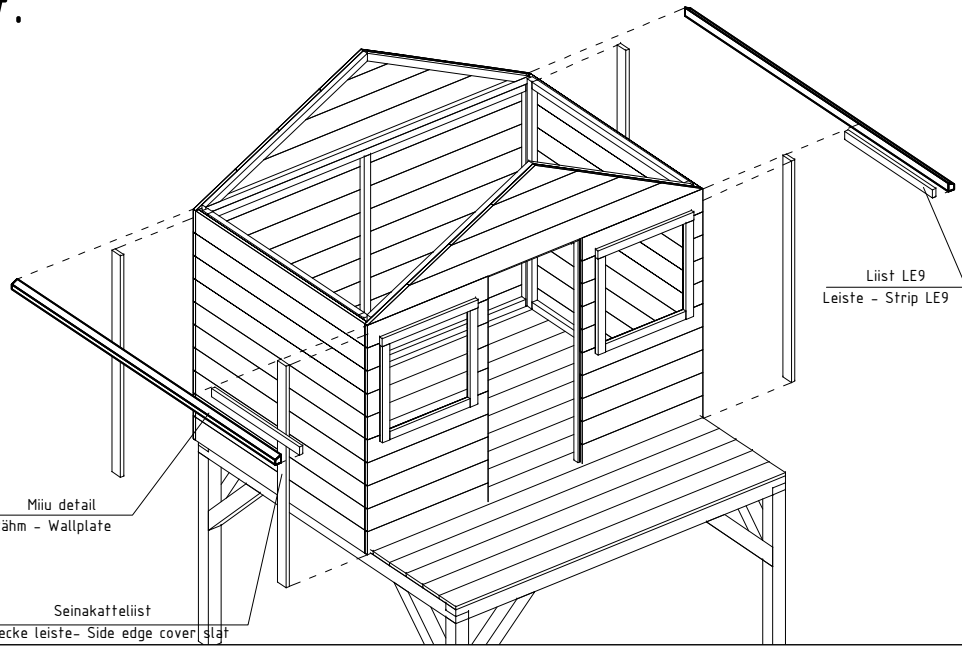

8.

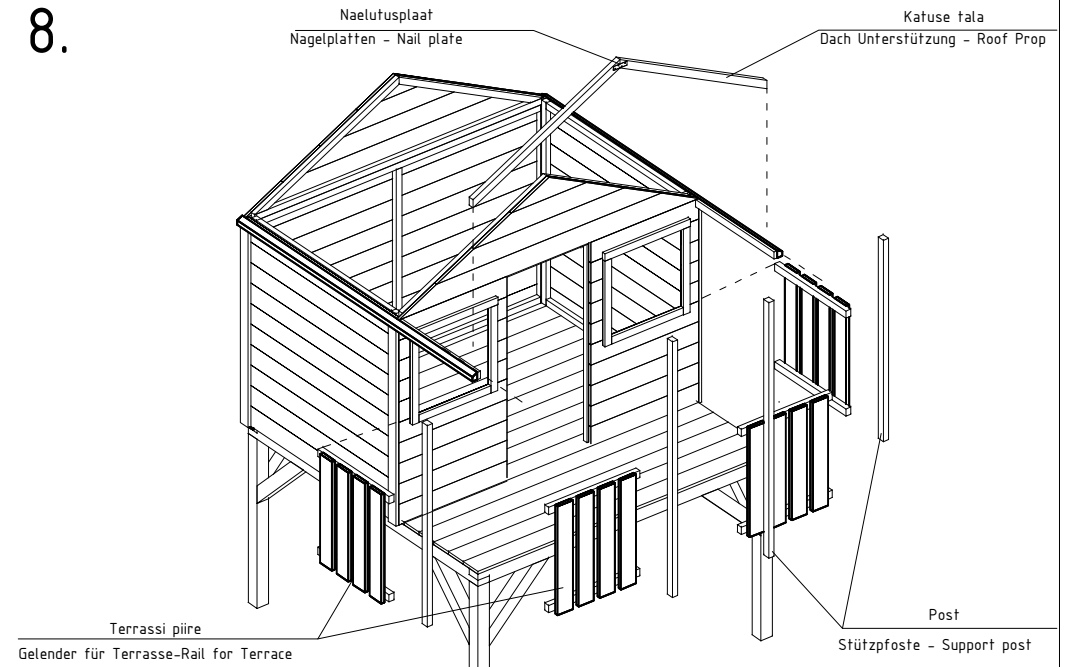

9.

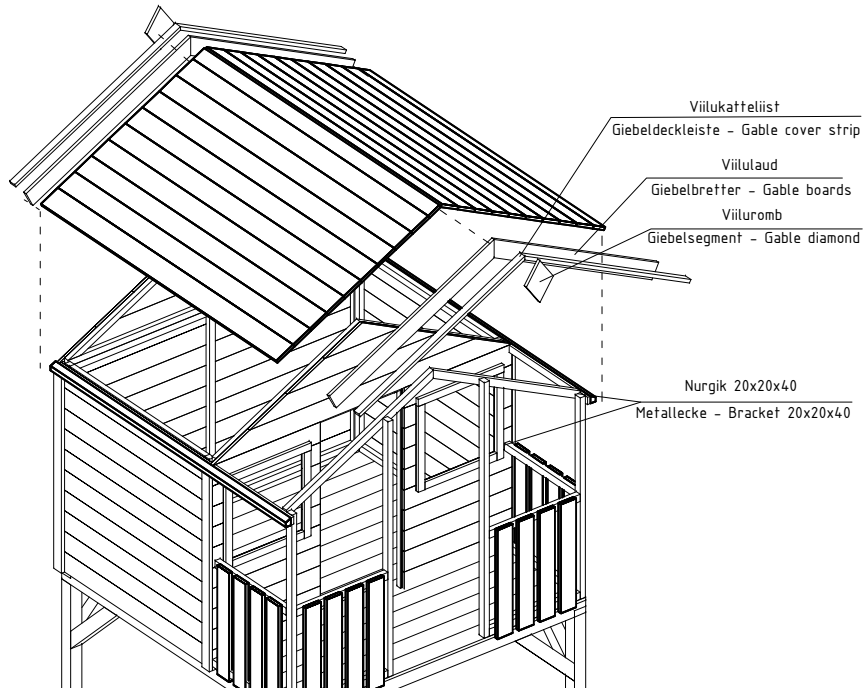

10.

