

Name	VS40_0010 415x595/40 Annabel			
Zeichnung/Drawing	3D	VS40_0010		
Profil/Profile	4.0x11.4	Maßstab/Scale	Druck auf/ Print on	
			Datum/Date	17.07.2025

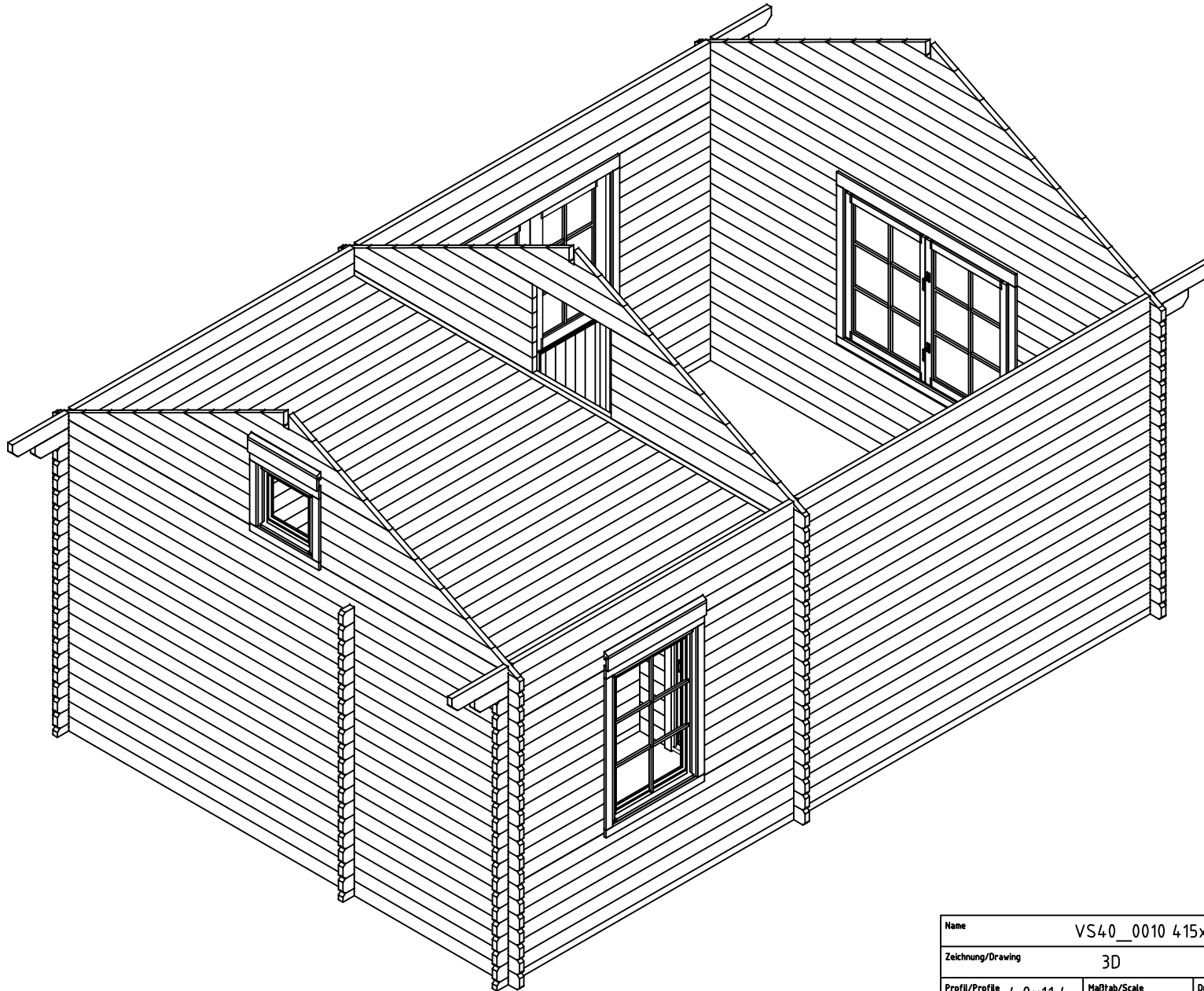

Name	VS40_0010 415x595/40 Annabel		
Zeichnung/Drawing	3D	VS40_0010	
Profil/Profile	4.0x11.4	Maßstab/Scale	Druck auf/ Print on
			Datum/Date
			17.07.2025

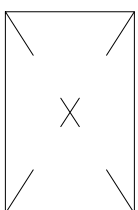
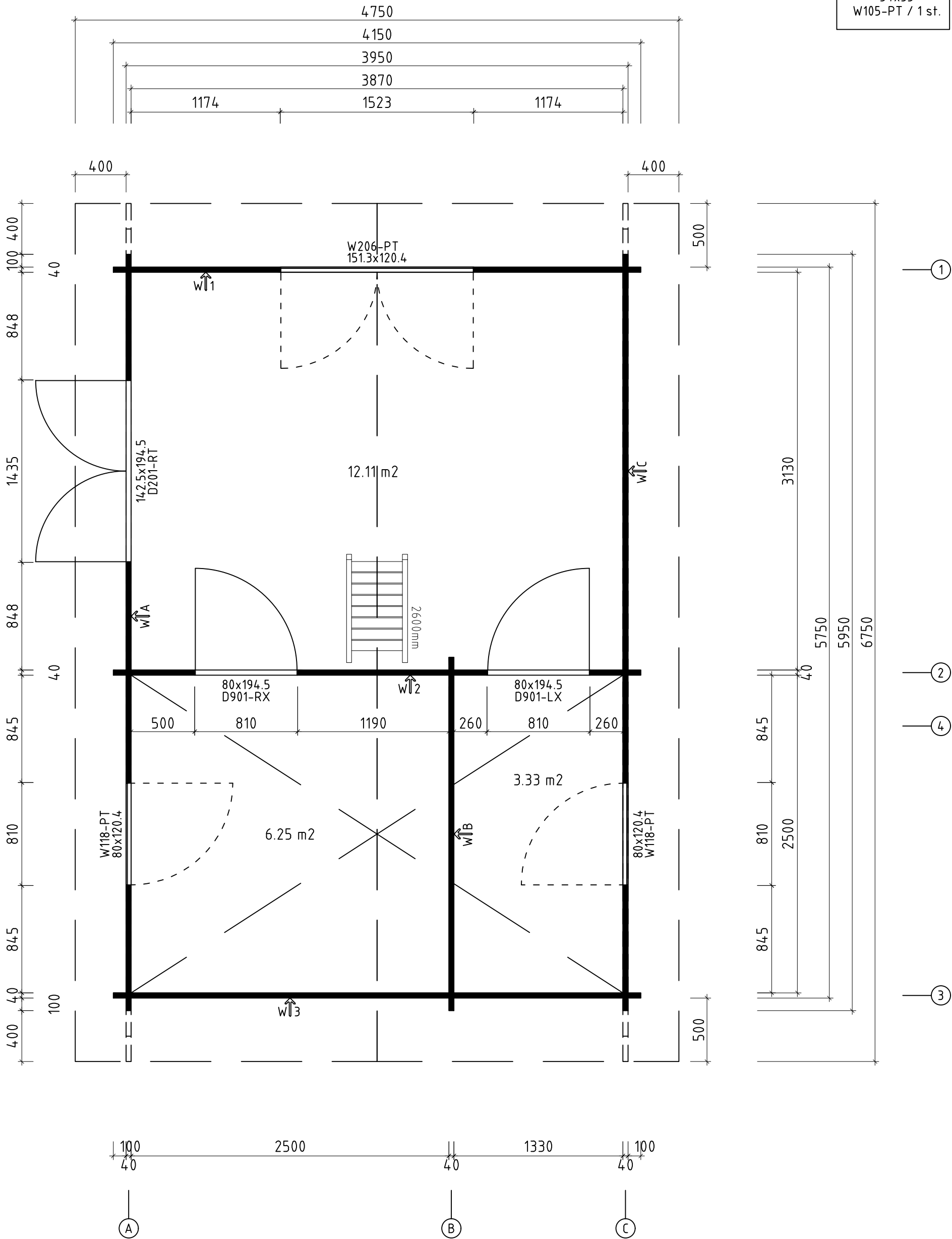
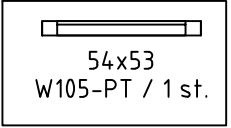

- Schlafboden/sleeping floor

Q3 - Qualitätsklasse für Fenster und Türen/  
Quality class for windows and doors

\* Fenster und Türen sind mit Sprossen/  
Windows and doors are with muntins

Name	VS40_0010 415x595/40 Annabel		
Zeichnung/Drawing	Grundplan; Plan	VS40_0010	
Profil/Profile	4.0x11.4	Maßstab/Scale	1:30
		Druck auf/Print on	A3
		Datum/Date	17.07.2025

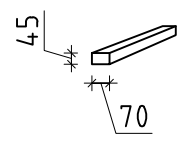
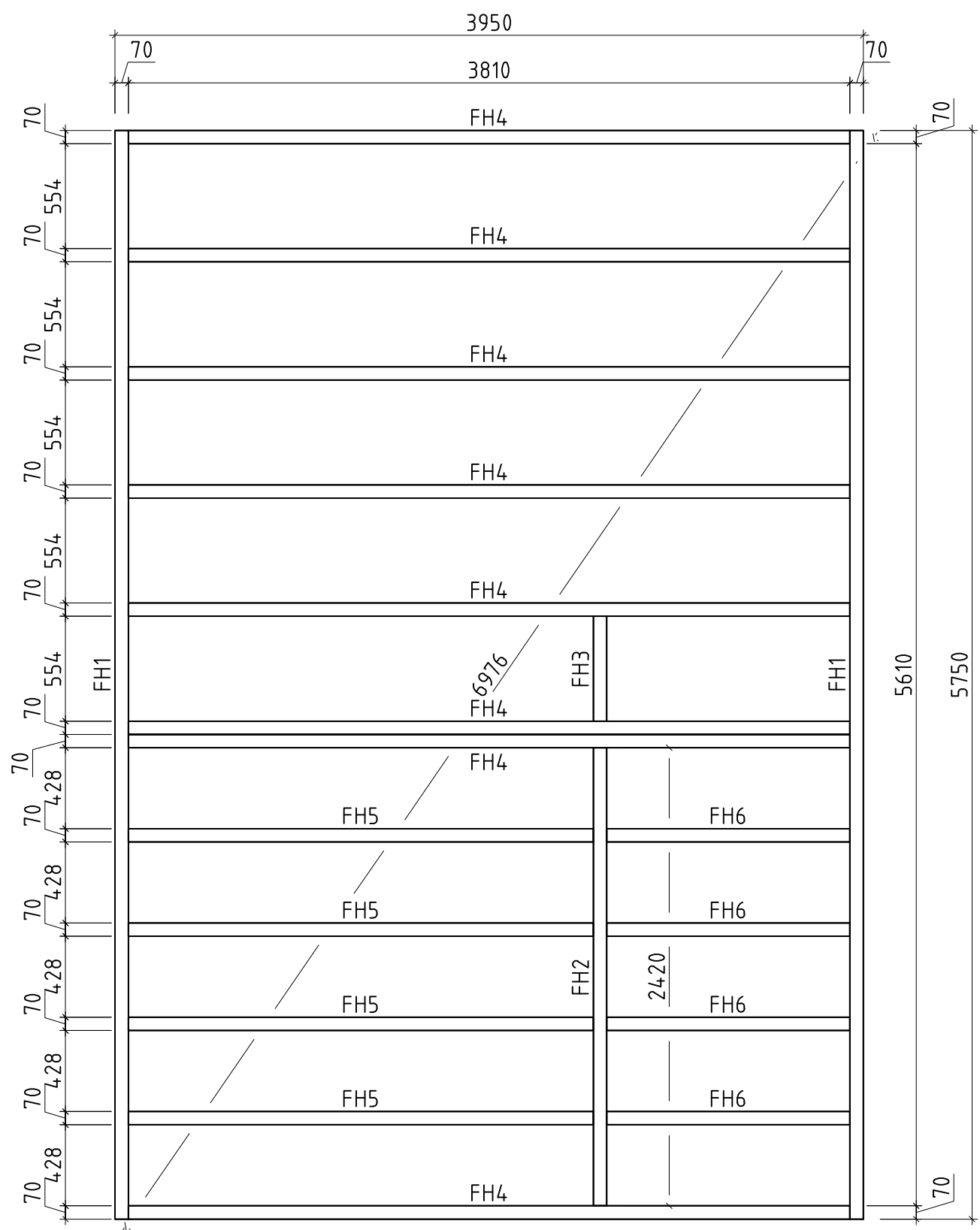

Name VS40_0010 415x595/40 Annabel			
Zeichnung/Drawing Lagerholzplan; Foundation beams		VS40_0010	
Profil/Profile 4.0x11.4	Maßstab/Scale 1:30	Druck auf/Print on A3	Datum/Date 17.07.2025

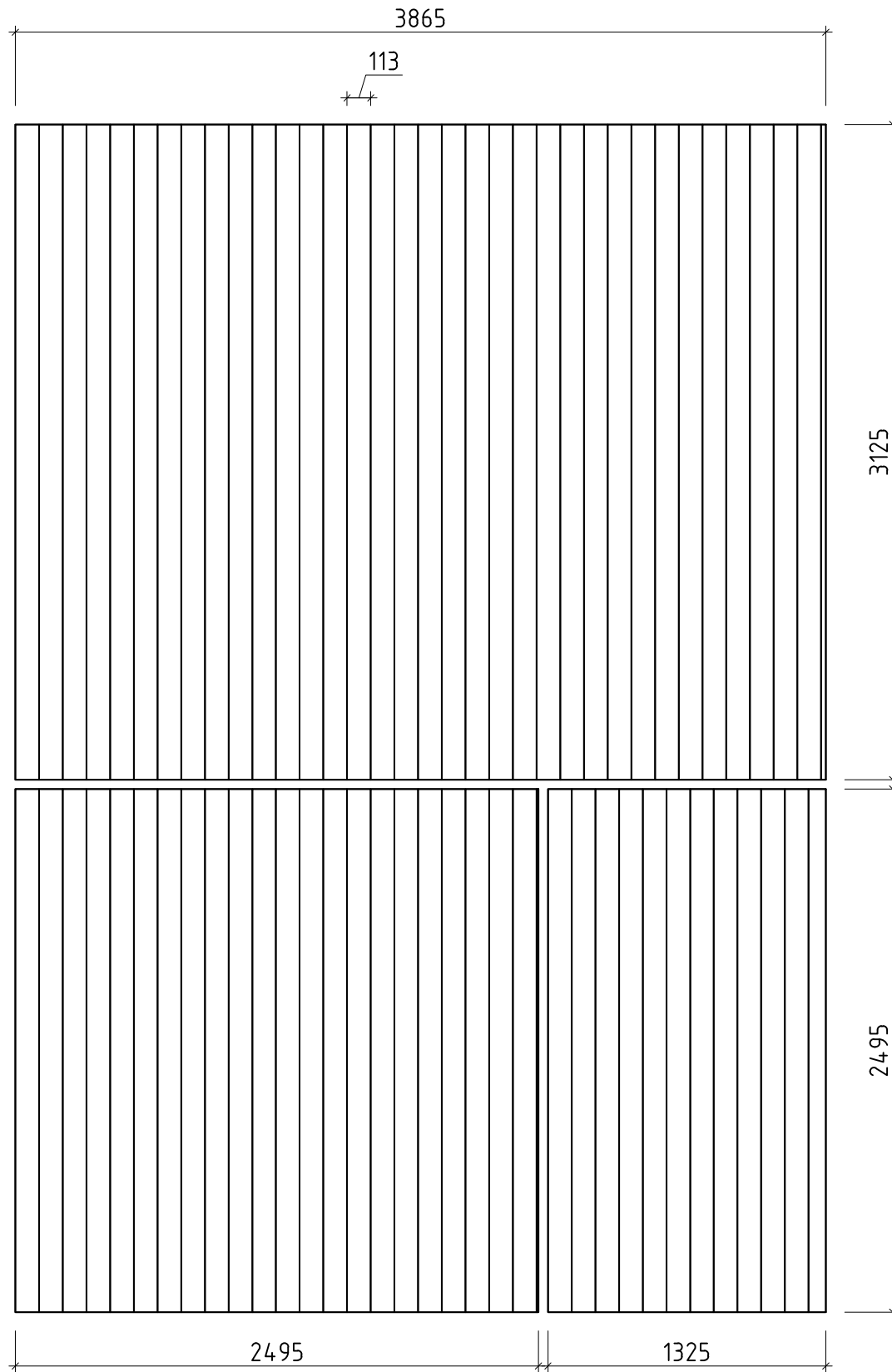

Name	VS40_0010 415x595/40 Annabel		
Zeichnung/Drawing	Fußbodenbretter; Floor boards	VS40_0010	
Profil/Profile	4.0x11.4	Maßstab/Scale	1:30
		Druck auf/Print on	A3
		Datum/Date	17.07.2025

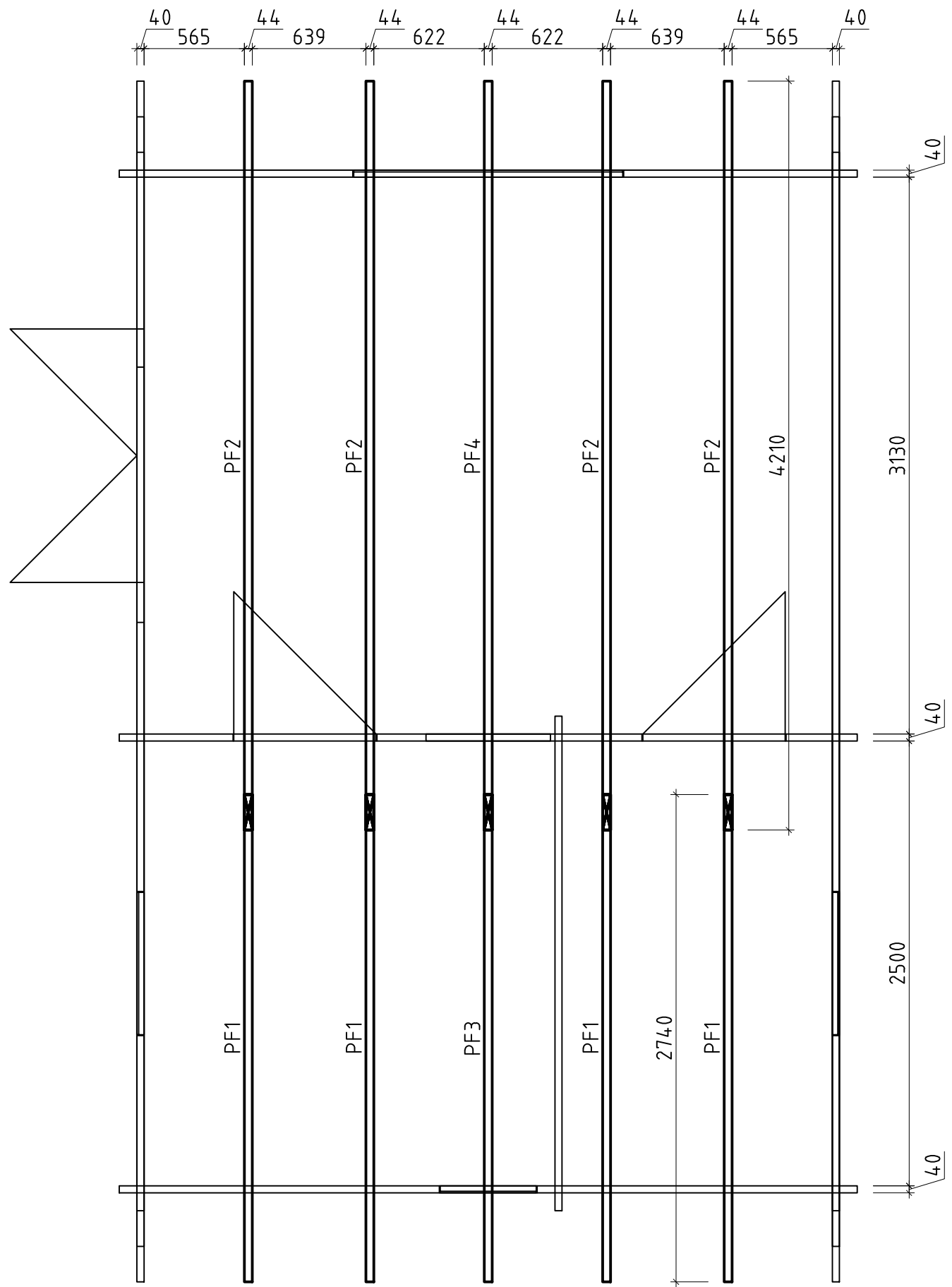

Name	VS40_0010 415x595/40 Annabel		
Zeichnung/Drawing	Pretten; Purlins 44x145 mm		VS40_0010
Profil/Profile	4.0x11.4	Maßstab/Scale	1:30
		Druck auf/Print on	A3
		Datum/Date	17.07.2025

- Giebeldeckleisten
- Gable cover strips
- Dachbretter
- Roof boards 18x113
- Giebelbretter
- Gable boards
- Pfetten/Wandbohlen
- Purlins/Wall log

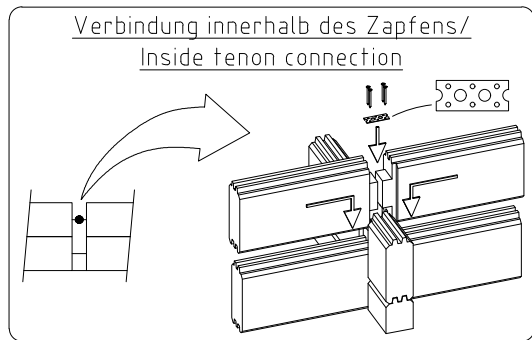
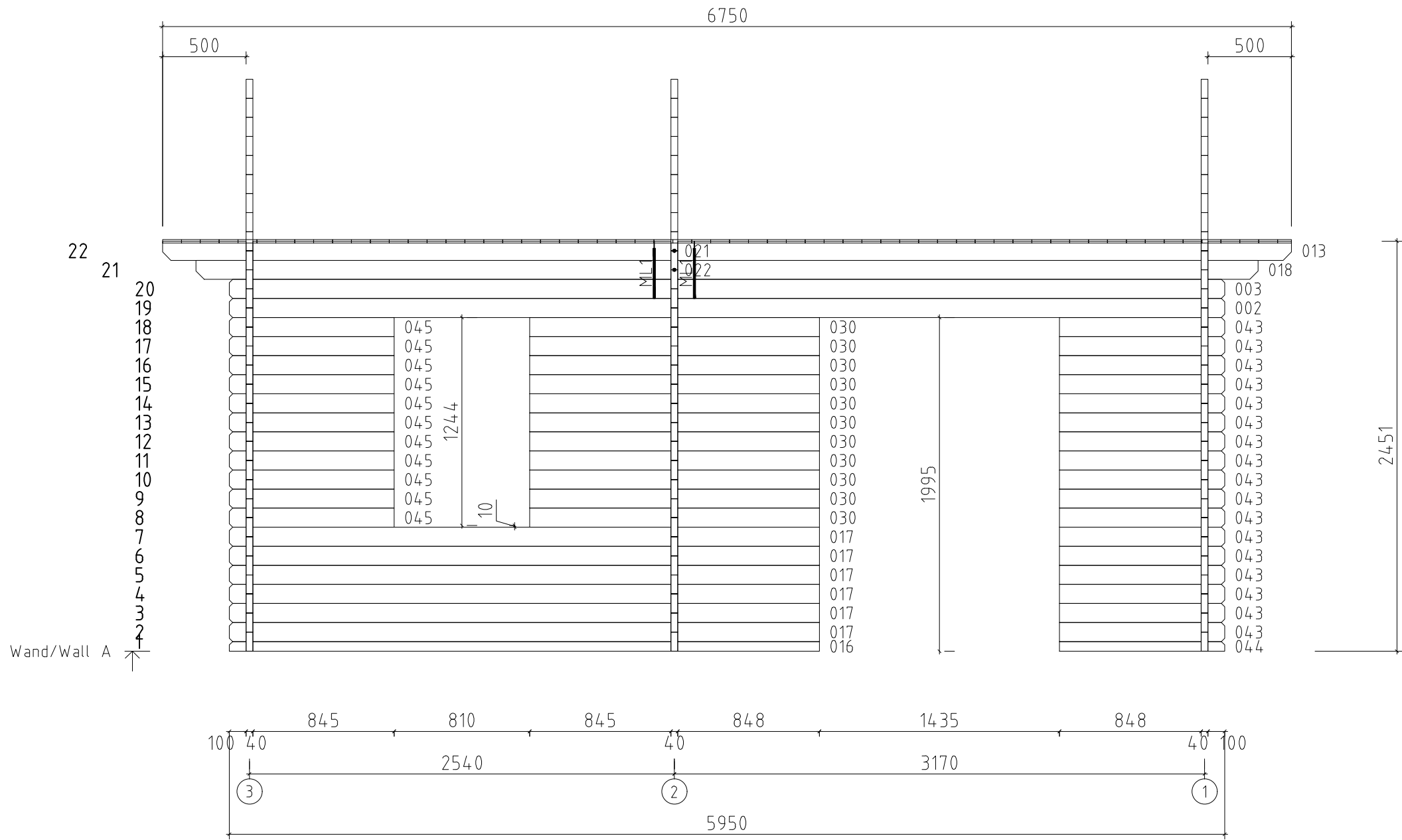

Name	VS40_0010 415x595/40 Annabel		
Zeichnung/Drawing	WAND/WALL A	VS40_0010	
Profil/Profile	4.0x11.4	Maßstab/Scale	1:30
		Druck auf/Print on	A3
		Datum/Date	17.07.2025

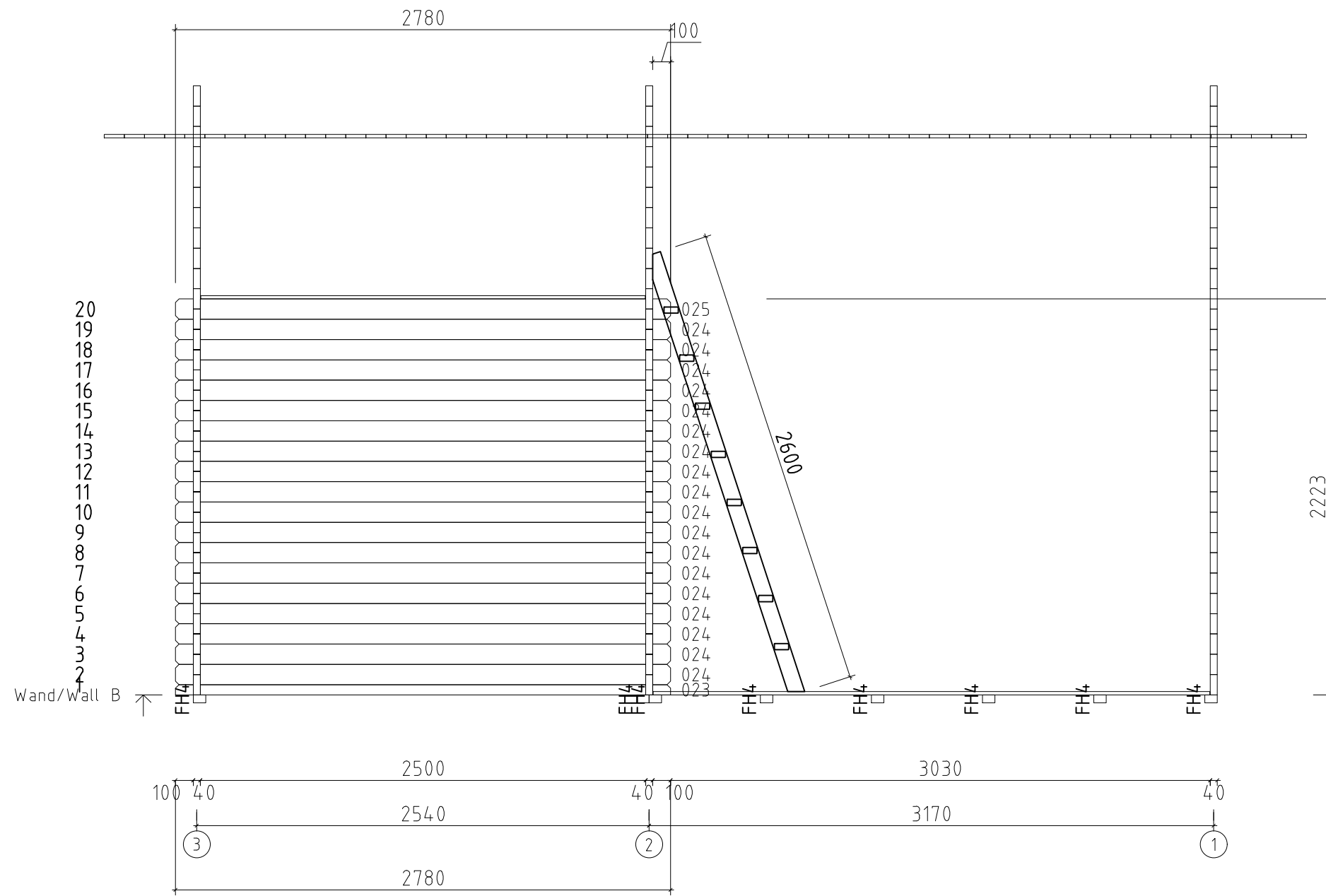

Name	VS40_0010 415x595/40 Annabel		
Zeichnung/Drawing	WAND/WALL B	VS40_0010	
Profil/Profile	4.0x11.4	Maßstab/Scale	1:30
		Druck auf/ Print on	A3
		Datum/Date	17.07.2025

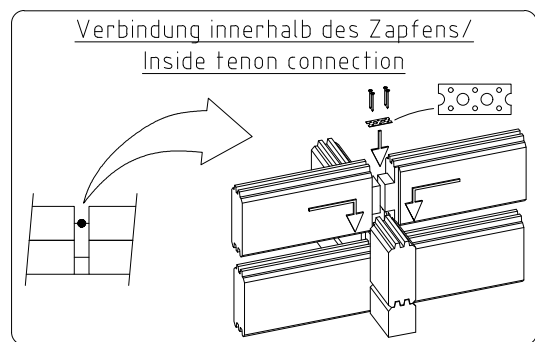
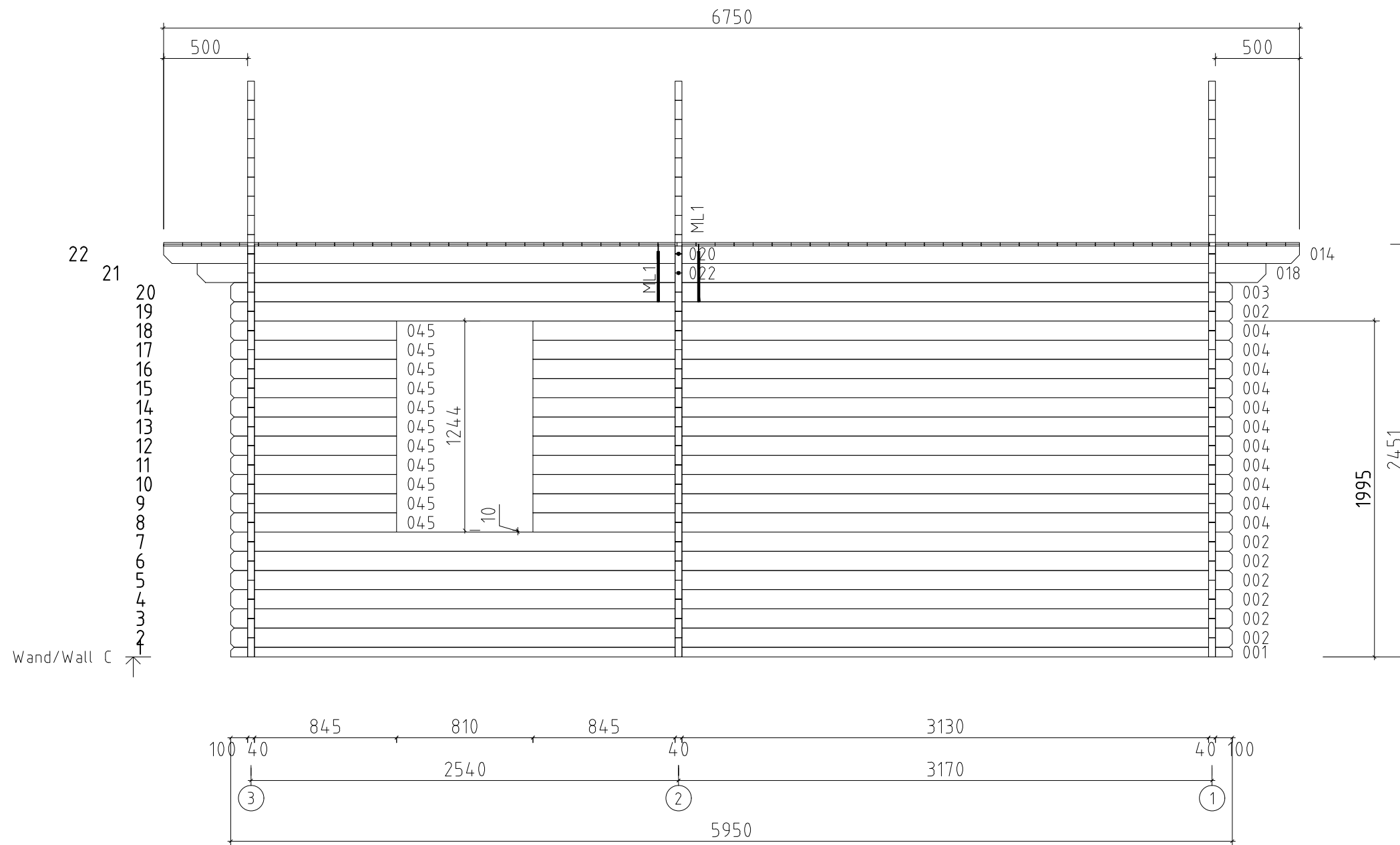



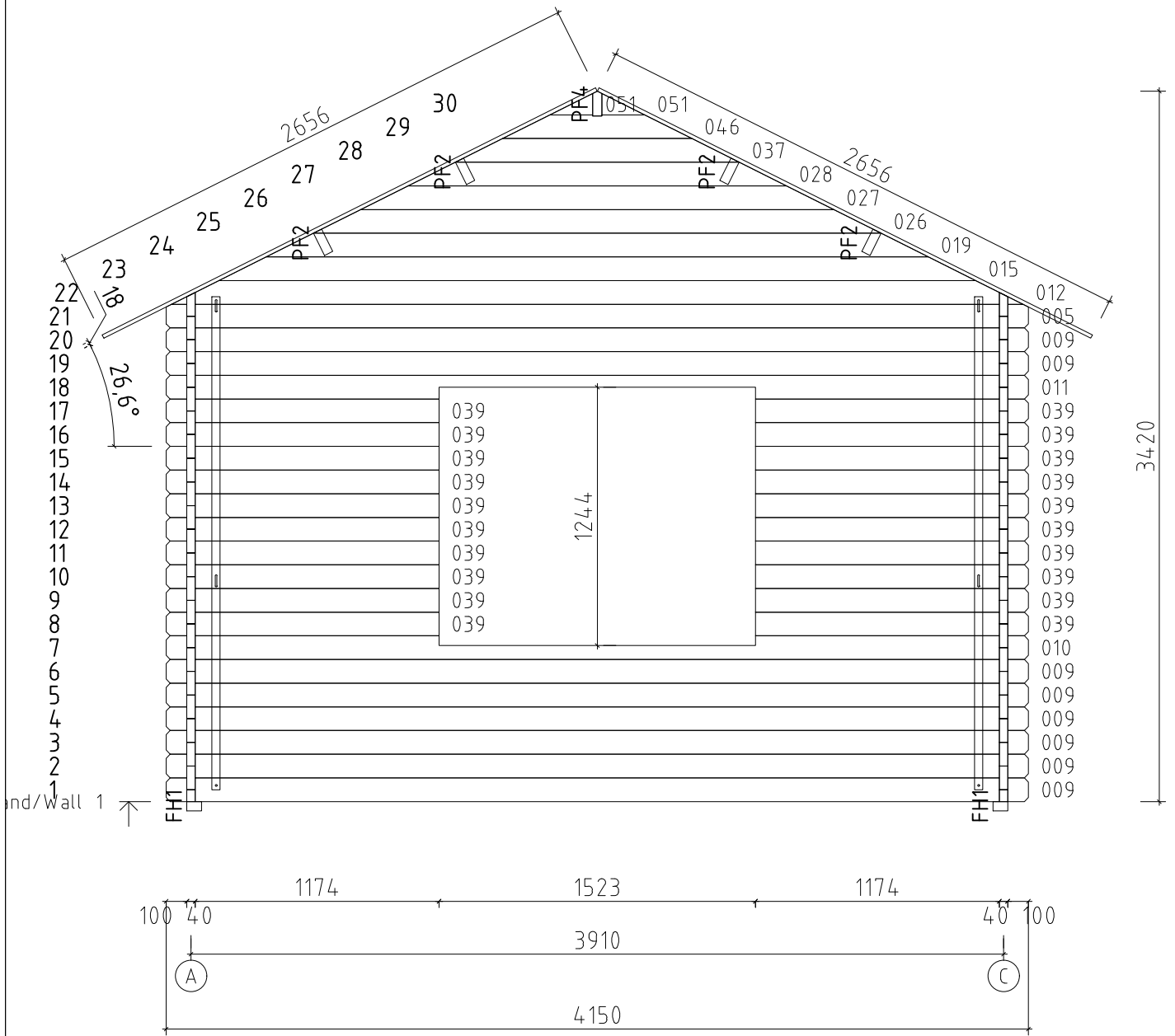
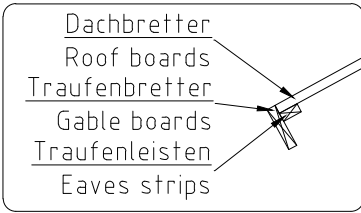







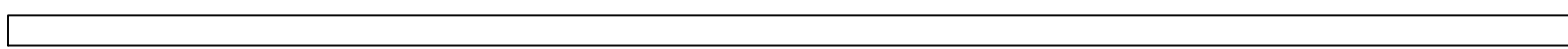

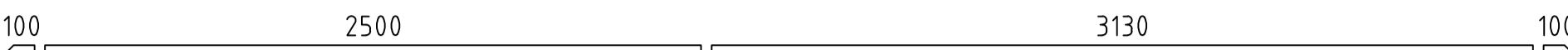

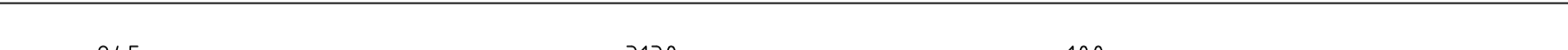
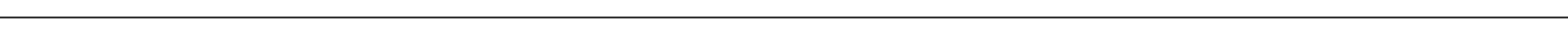
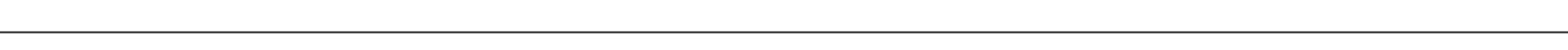
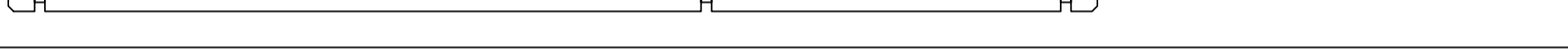
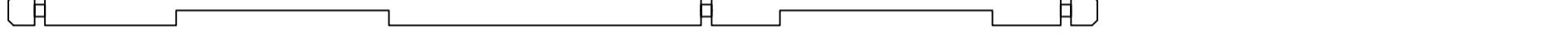
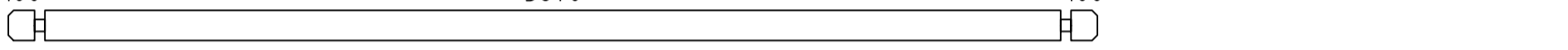
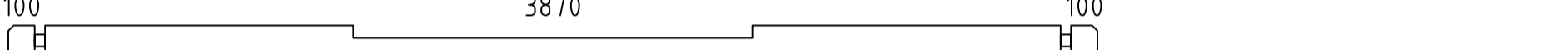
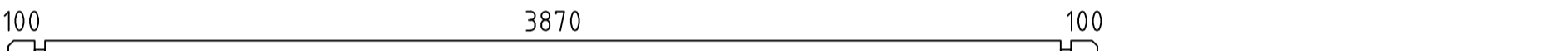
Name	VS40_0010 415x595/40 Annabel		
Zeichnung/Drawing	WAND/WALL C	VS40_0010	
Profil/Profile	4.0x11.4	Maßstab/Scale	1:30
		Druck auf/ Print on	A3
		Datum/Date	17.07.2025



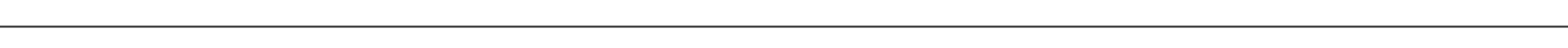
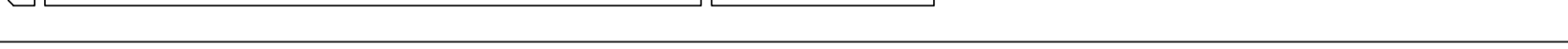
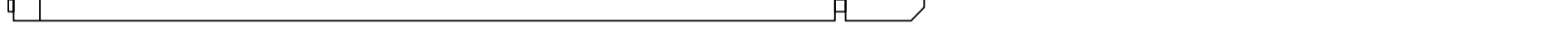
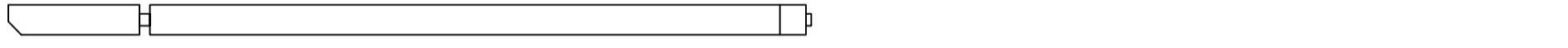

Name VS40_0010 415x595/40 Annabel			
Zeichnung/Drawing WAND/WALL 1		VS40_0010	
Profil/Profile 4.0x11.4	Maßstab/Scale 1:30	Druck auf/Print on A4	Datum/Date 17.07.2025



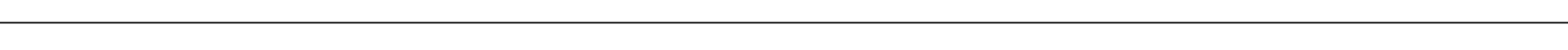

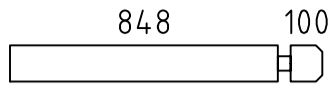
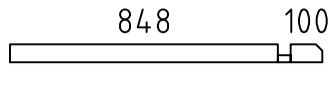
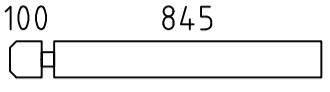
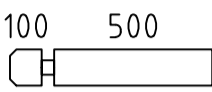
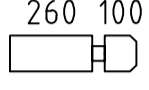
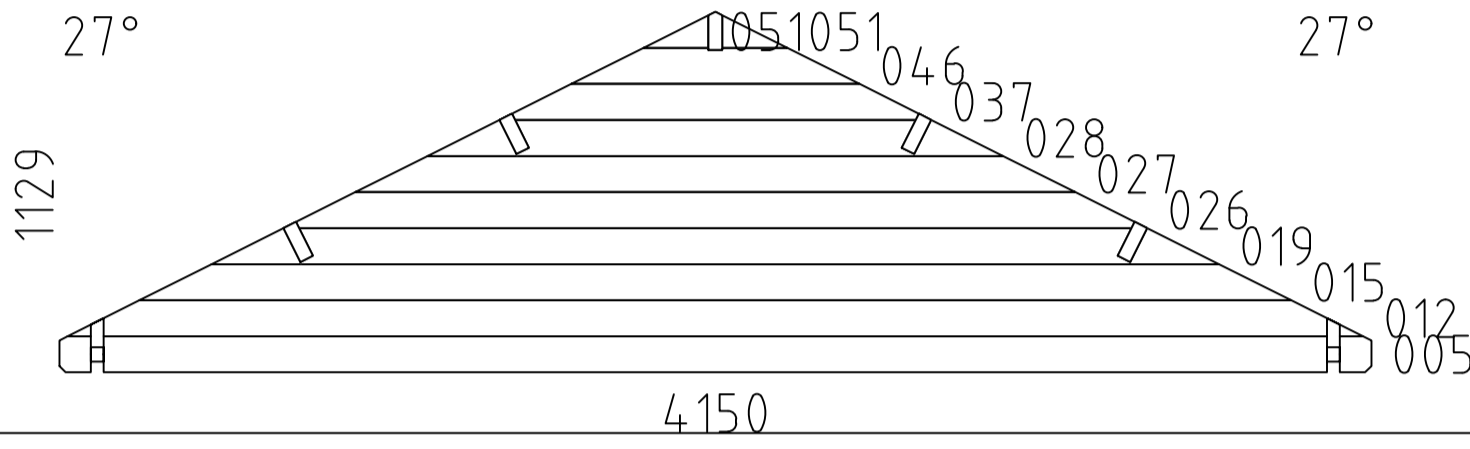
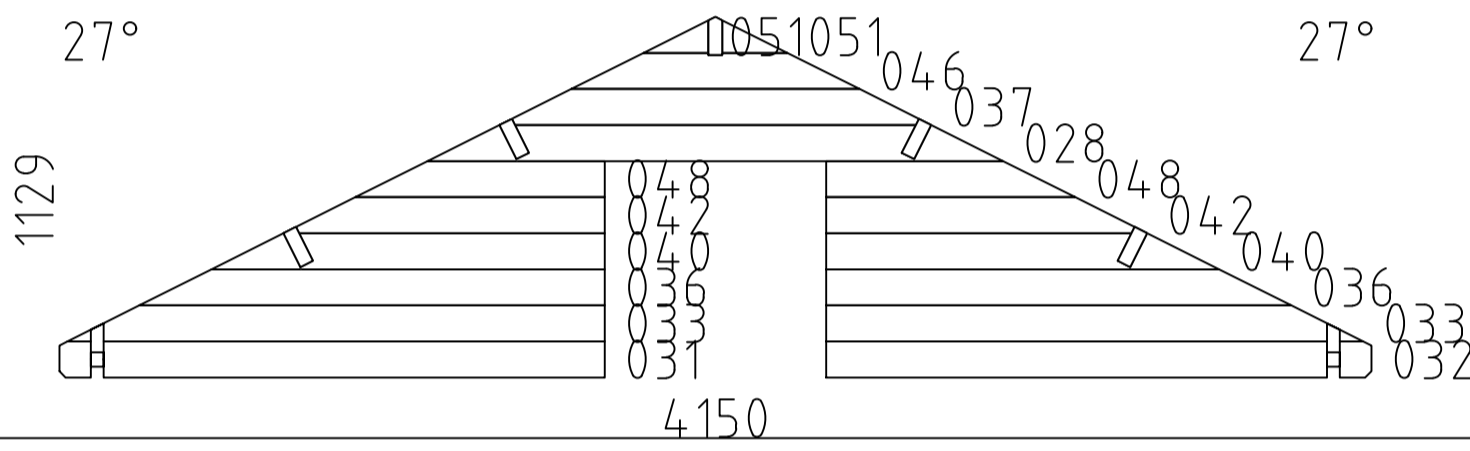
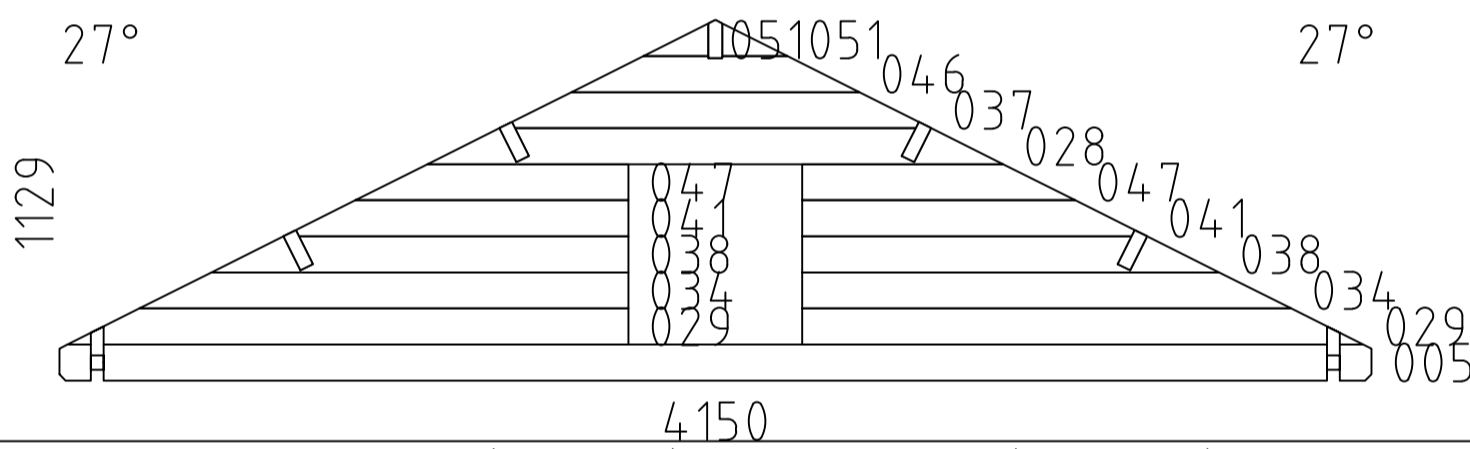
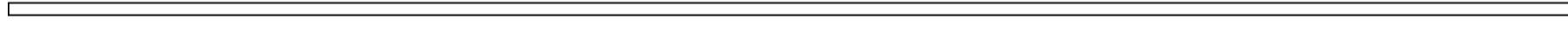
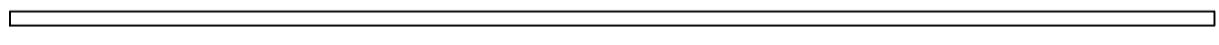
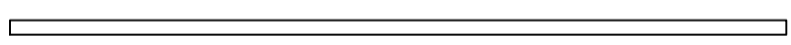
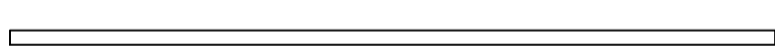
Pos	Teileliste/Specification VS40_0010 415x595/40 Annabel	Pcs.	Profile (mm)	Length (mm)
1extra		1	40x114	5950
001		1	40x57	5950
002		8	40x114	5950
003		2	40x114	5950
004		11	40x114	4155
006		20	40x114	4150
007		2	40x114	4150
008		1	40x114	4150
009		8	40x114	4150
010		1	40x114	4150
011		1	40x114	4150
013		1	40x114	3690
014		1	40x114	3690
016		1	40x57	3528
017		6	40x114	3528
018		2	40x114	3490
020		1	40x114	3060
021		1	40x114	3060
022		2	40x114	2860
023		1	40x57	2780
024		18	40x114	2780
025		1	40x114	2780
030		11	40x114	1733
035		17	40x114	1490
039		20	40x114	1314
Kood	VS40_0010 415x595/40 Annabel	Materjal		Leht 1/10

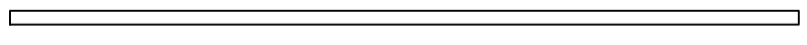
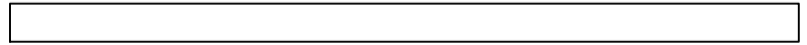
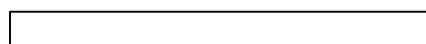
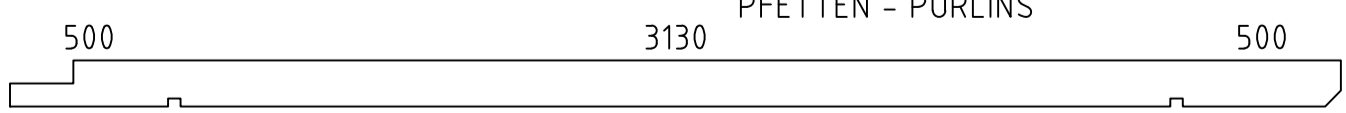
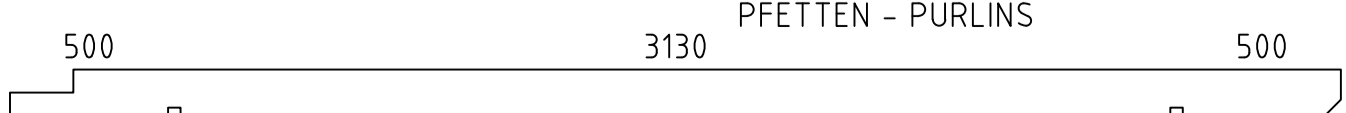
Pos	Teileliste/Specification VS40_0010 415x595/40 Annabel	Pcs.	Profile (mm)	Length (mm)
043		17	40x114	988
044		1	40x57	988
045		22	40x114	985
049		17	40x114	640
050		17	40x114	400
W1-1		1		
W2-1		1		
W3-1		1		
FH1	FUNDAMENTHOLZ (imprägniert) - FOUNDATION BEAM (impregnated) 	2	70x45	5750
FH4	FUNDAMENTHOLZ (imprägniert) - FOUNDATION BEAM (impregnated) 	8	70x45	3810
FH5	FUNDAMENTHOLZ (imprägniert) - FOUNDATION BEAM (impregnated) 	4	70x45	2455
FH2	FUNDAMENTHOLZ (imprägniert) - FOUNDATION BEAM (impregnated) 	1	70x45	2420
FH6	FUNDAMENTHOLZ (imprägniert) - FOUNDATION BEAM (impregnated) 	4	70x45	1285
FH3	FUNDAMENTHOLZ (imprägniert) - FOUNDATION BEAM (impregnated) 	1	70x45	554
DT1	DECKENTRÄGER - COVER CARRIER 	4	44x44	2495
TB1	TRÄGEBALKE - SUPPORT BEAM 	6	40x120	2495
TB2	TRÄGEBALKE - SUPPORT BEAM 	6	40x120	1325
PF2	PFETTEN - PURLINS 	4	44x145	4210
PF4	PFETTEN - PURLINS 	1	44x145	4210
Kood	VS40_0010 415x595/40 Annabel	Materjal		Leht 2/10

Pos	Teileliste/Specification VS40_0010 415x595/40 Annabel		Pcs.	Profile (mm)	Length (mm)	
PF1	PFETTEN - PURLINS		4	44x145	2740	
PF3	PFETTEN - PURLINS		1	44x145	2740	
	DACHBRETTER - ROOF BOARDS		120+2	113x18	2656	
	FUSSBODENBRETTER - FLOOR BOARDS		35+1	113x18	3125	
	FUSSBODENBRETTER - FLOOR BOARDS		35	113x18	2495	
	SCHLAFBODENBRETTER - SLEEPING FLOOR BOARDS		35+1	113x18	2495	
	DECKENLEISTEN - CEILING STRIPS			15x28	46,0 lfm/rm	
	FUSSBODENLEISTEN - FLOOR STRIPS			18x40	34,0 lfm/rm	
	SCHLAFBODENLEISTEN - SLEEPING FLOOR STRIPS			18x40	14,0 lfm/rm	
G02-1	GIEBELBRETTER - GABLE BOARDS 18x120	26,6°	✓	4	18x120	2736
G06-1	GIEBELDECKLEISTEN - GABLE COVER STRIPS 18x58		✓	4	18x58	2736
T01-1	TRAUFBRETTER - EAVES BOARDS 18x95			4	18x95	3375
T06-1	TRAUFBRETTER - EAVES STRIPS 18x40		✓		18x40	14,0 lfm/rm
GS	GIEBELSEGMENT - GABLE DIAMOND			2		
UP2-1	U-PROFIL - U-PROFILE 40		✓	2	44x65	744
UP2-2	U-PROFIL - U-PROFILE 40		✓	2	44x65	760
SM-1	Sturmleisten - Storm reinforcement			4	18x40	2374
ML1	Metallstange - Metal bar			4	D10	300
SH	SCHLAGHÖLZER - MOUNTING PIECES			3		
NG2 550	NÄGEL - NAILS 2.5x50 Dachbretter - Roof boards			960		
NG2 550	NÄGEL - NAILS 2.5x50 Fussbodenbretter - Floor boards			840		
NG2 550	NÄGEL - NAILS 2.5x50 Schlafbodenbretter - Sleeping floor boards			420		
SR3 030	Schrauben - Screws 3.0x30 Deckenleisten - Ceiling strips			92		
SR3 030	Schrauben - Screws 3.0x30 Fussbodenleisten - Floor strips			84		
SR3 030	Schrauben - Screws 3.0x30 Schlafbodenleisten - Sleeping floor strips			28		
Kood	VS40_0010 415x595/40 Annabel		Materjal		Leht 3/10	















# Pärilinite ühendamine / Verbinden der Pfetten / Connecting purlins

1

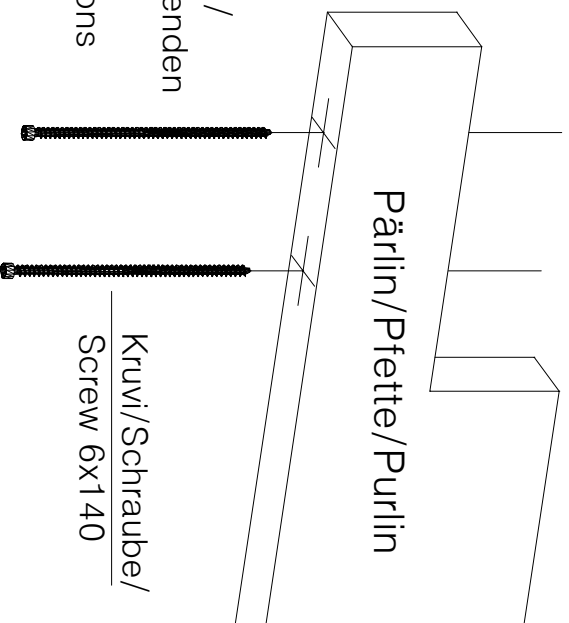
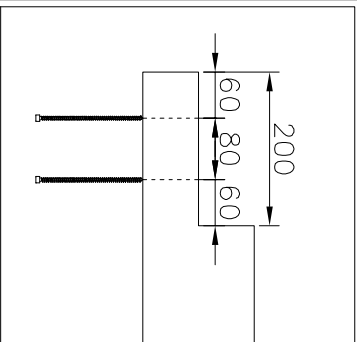

Märkige kruvide asukohad /  
Markieren Sie die empfehlenden  
Schraubenpositionen /  
Mark the suggested positions  
for screws

2

Keerake kruvid poole ulatuses sisse.  
(Vaja läheb Assy AW30 või Torx T30 otsikut) ☆  
Drehen Sie die Schrauben bis zur Hälfte  
seiner Länge ein.

(Für diese Schrauben benötigen Sie einen  
Assy AW30 oder Inrentorx T30  
Schraubereinsatz) ☆

Turn the screws up  
until the first half.

(These screws require Assy AW30  
or Torx T30 driver bit) ☆

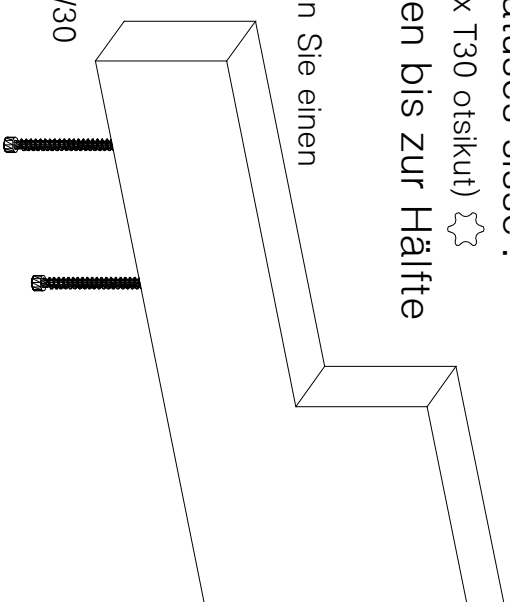

3

Hoja ühendatavad pärilnid tihedalt koos /  
Setzen Sie die Enden der Balken zusammen /  
Keep purlins tight together

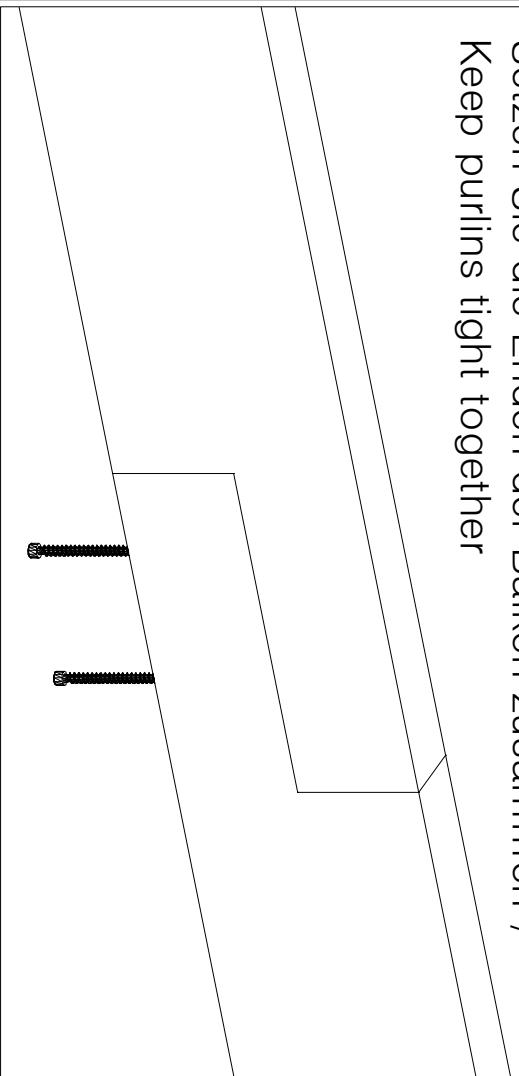

4

Keera kruvid lõpuni sisse /  
Drehen Sie die Schrauben dann ganz ein /  
Turn the screws up until the end

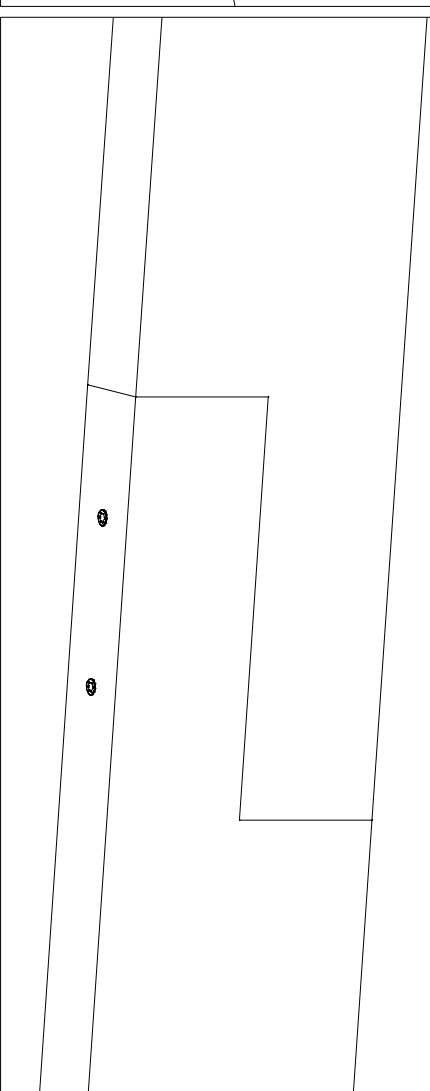

## Vihmaliist / Rain strip / Wasserleiste

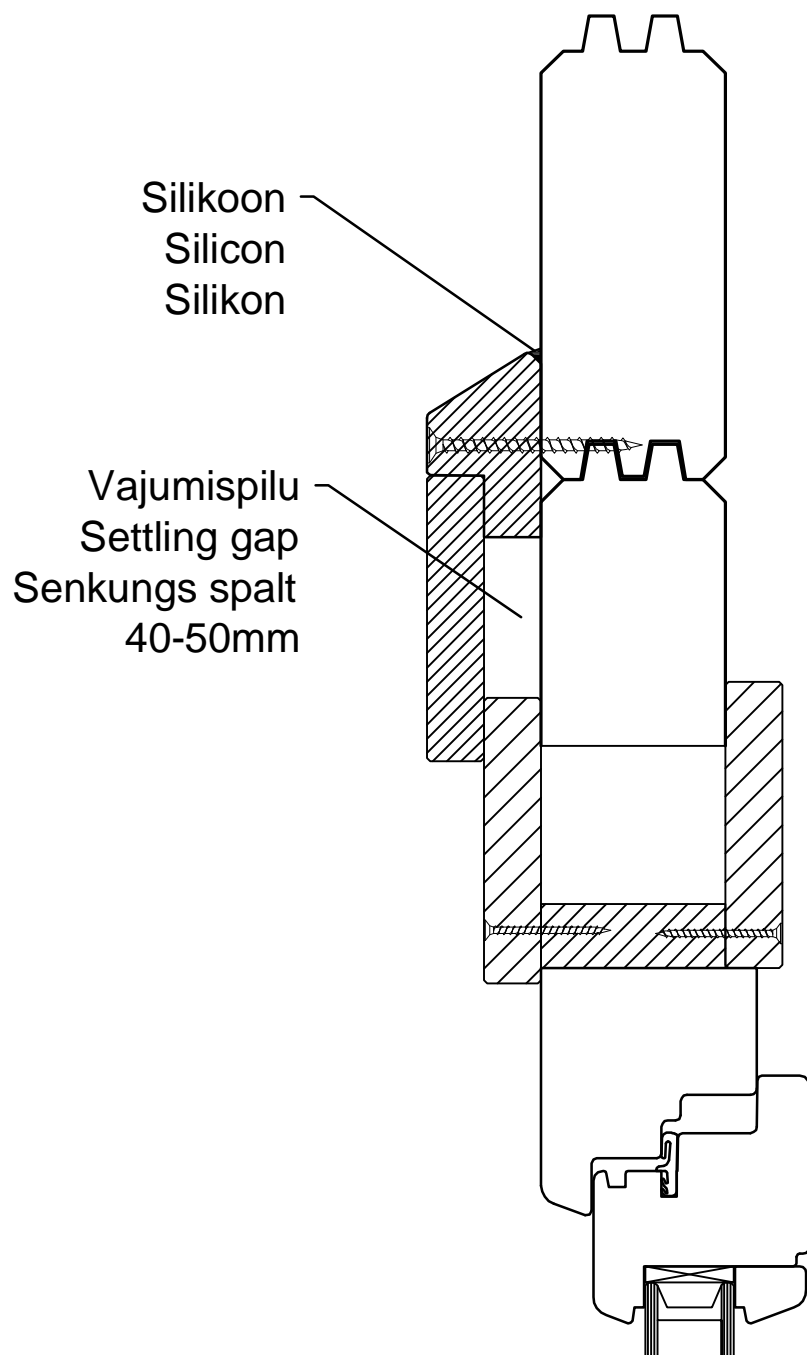

NB!

- Monteerida juhul kui ese on välja toodud maja spetsifikatsioonis!
- Install only if the item is listed in the house specification!
- Nur montieren wenn die Leiste in der Teileliste gezeigt ist!

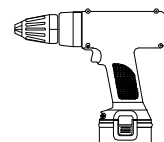

Uks	Q2-Q3	-	koostamisjuhhis
Door	Q2-Q3	-	assembly instructions
Tür	Q2-Q3	-	Montageanleitung

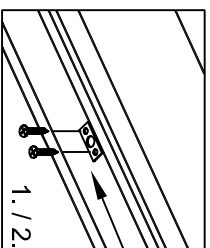
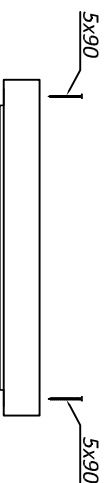

Ø8-10

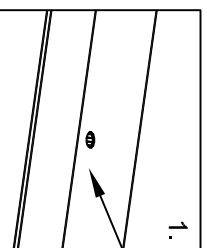
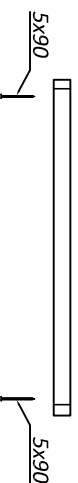
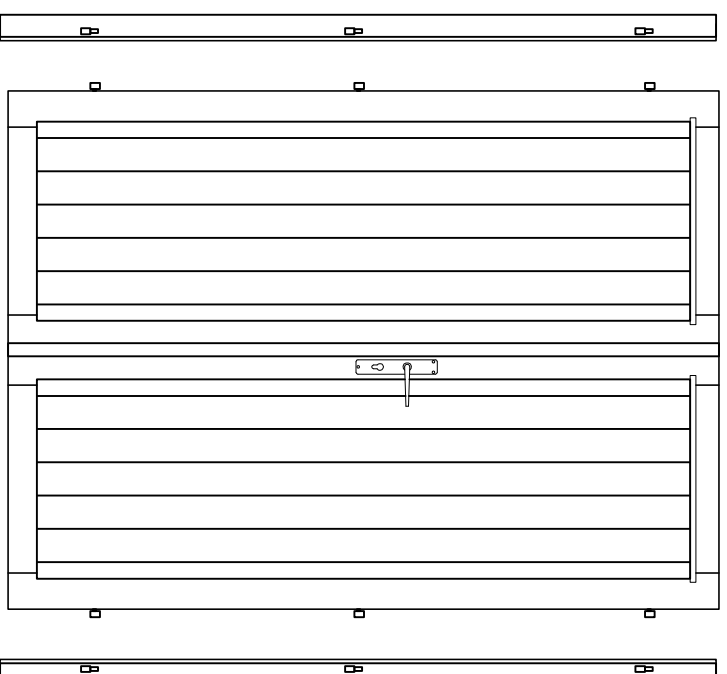
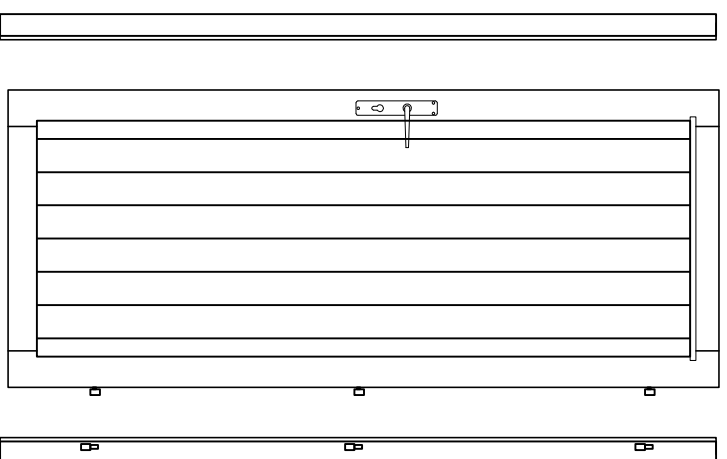
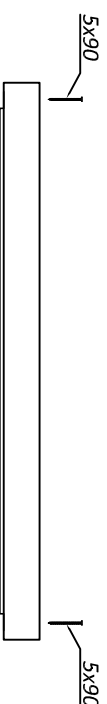

Ø8-10

\*Kui ühepoolne uks ei ole kokku pandud!  
 \*When single door is not assembled!  
 \*Wenn Einzeltür ist nicht zusammengebaut!

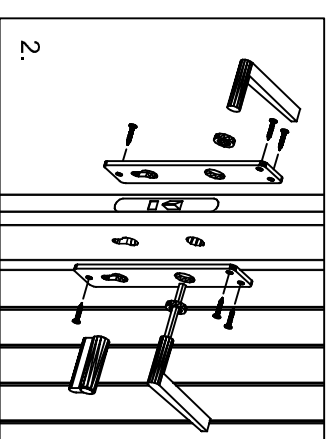
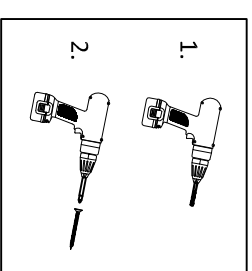

\*Kui hinged ei ole paigaldatud!  
 \*When hinges are not attached!  
 \*Wenn Scharniere sind nicht angebracht!

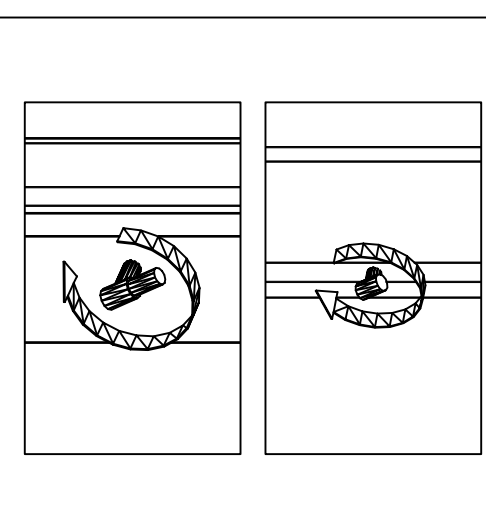

Rain strip / Wasserleiste / Vihmaliist

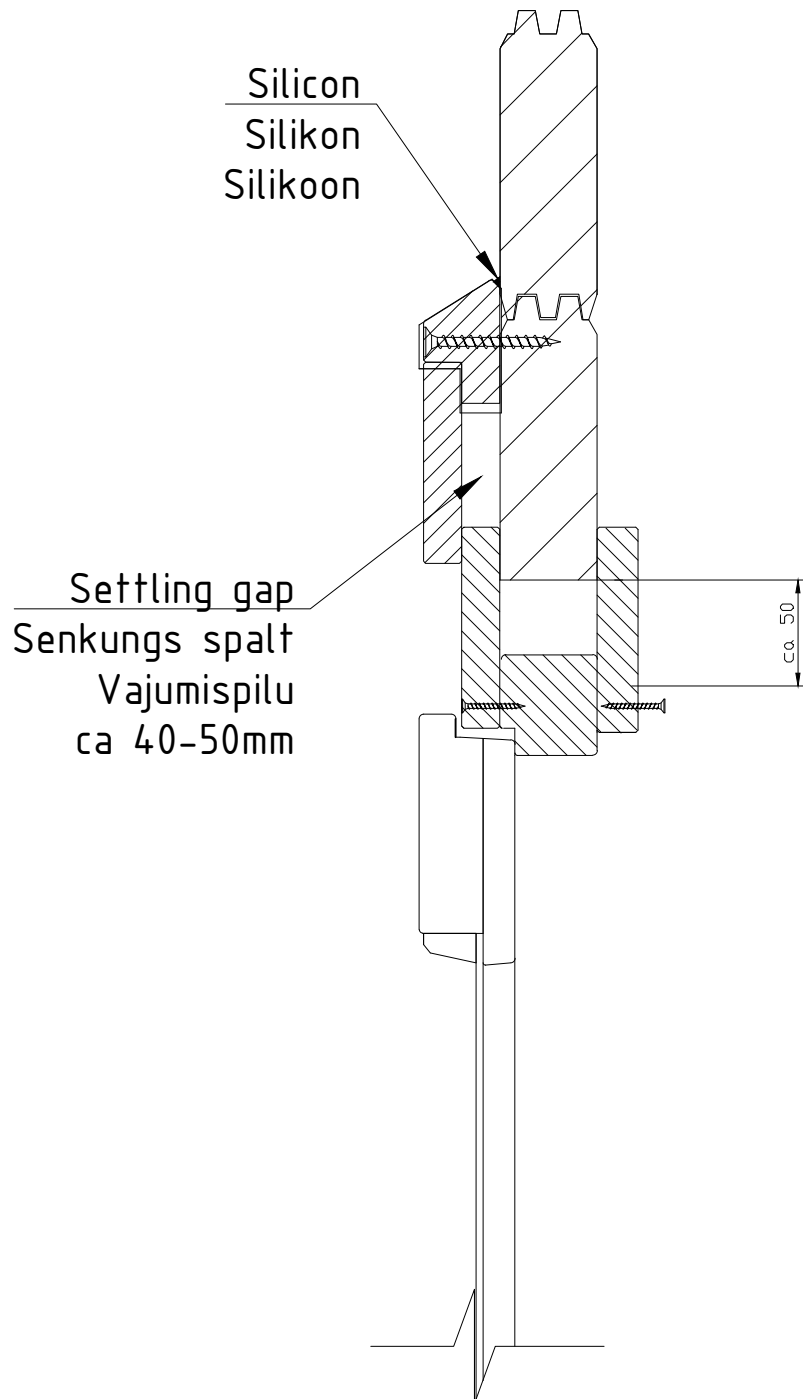

NB!

- Install only if the item is listed in the house specification!
- Nur montieren wenn die Leiste in der Teileliste gezeigt ist!
- Monteerida juhul, kui liist on välja toodud maja spetsifikatsioonis!

DT1

TB1/TB2

